

Troubleshooting

Click the icon of the function you want to know more about.



Common



Copier



Printer



Fax



Image Send



Document Filing



Useful Tips

Preface

ABOUT THIS GUIDE

This guide provides information about how to use the machine and what to do when a problem occurs. If you encounter a problem, check this guide before calling a support center.

Please note

- This guide assumes that the persons who install and use this product have a working knowledge of their computer and web browser.
- For information on your operating system or web browser, please refer to your operating system guide or web browser guide, or the online Help function.
- The explanations of screens and procedures are primarily for Internet Explorer® on Windows® 10. The screens may vary depending on the version of the operating system or the software application.
- Wherever "MX-xxxx" appears in this guide, please substitute your model name for "xxxx".
- Considerable care has been taken in preparing this manual. If you have any comments or concerns about the manual, please contact your dealer or nearest authorized service representative.
- This product has undergone strict quality control and inspection procedures. In the unlikely event that a defect or other problem is discovered, please contact your dealer or nearest authorized service representative.
- Aside from instances provided for by law, SHARP is not responsible for failures occurring during the use of the product or its options, or failures due to incorrect operation of the product and its options, or other failures, or for any damage that occurs due to use of the product.

Warning

- Reproduction, adaptation or translation of the contents of the manual without prior written permission is prohibited, except as allowed under copyright laws.
- All information in this manual is subject to change without notice.

Illustrations and the operation panel and touch panel shown in this manual

The peripheral devices are generally optional, however, some models include certain peripheral devices as standard equipment.

The explanations in this manual assume that a paper drawer is installed on the MX-M6070.

The explanations in this manual are based on American English and the North American version of the software.

For some functions and procedures, the explanations assume that devices other than the above are installed.

The display screens, messages, and key names shown in the manual may differ from those on the actual machine due to product improvements and modifications.

CONTENTS

ABOUT THIS GUIDE	2
General Problems	4
Copying Problems	25
Printing Problems	29
Fax Problems	38
Image Send Problems	48
Document Filing Problems	56
Useful Tips	60

If the problem persists after you follow the instructions in this guide...

If you are unable to solve a problem using the solutions in this manual, press the [Power] button and then turn the main power switch to the "⏻" position. Wait at least 10 seconds and then turn the main power switch to the " | " position. After the main power indicator color changes to green, press the [POWER] button.



When the background color of the job status display at the upper right corner of the touch panel is not gray, do not switch off the main power switch or unplug the power plug. This may damage the hard drive or cause the data being stored or received to be lost.



Points to Keep in Mind

For a checklist of general problems, refer to "[CHECK LIST \(page 7\)](#)".

Power and connector positions

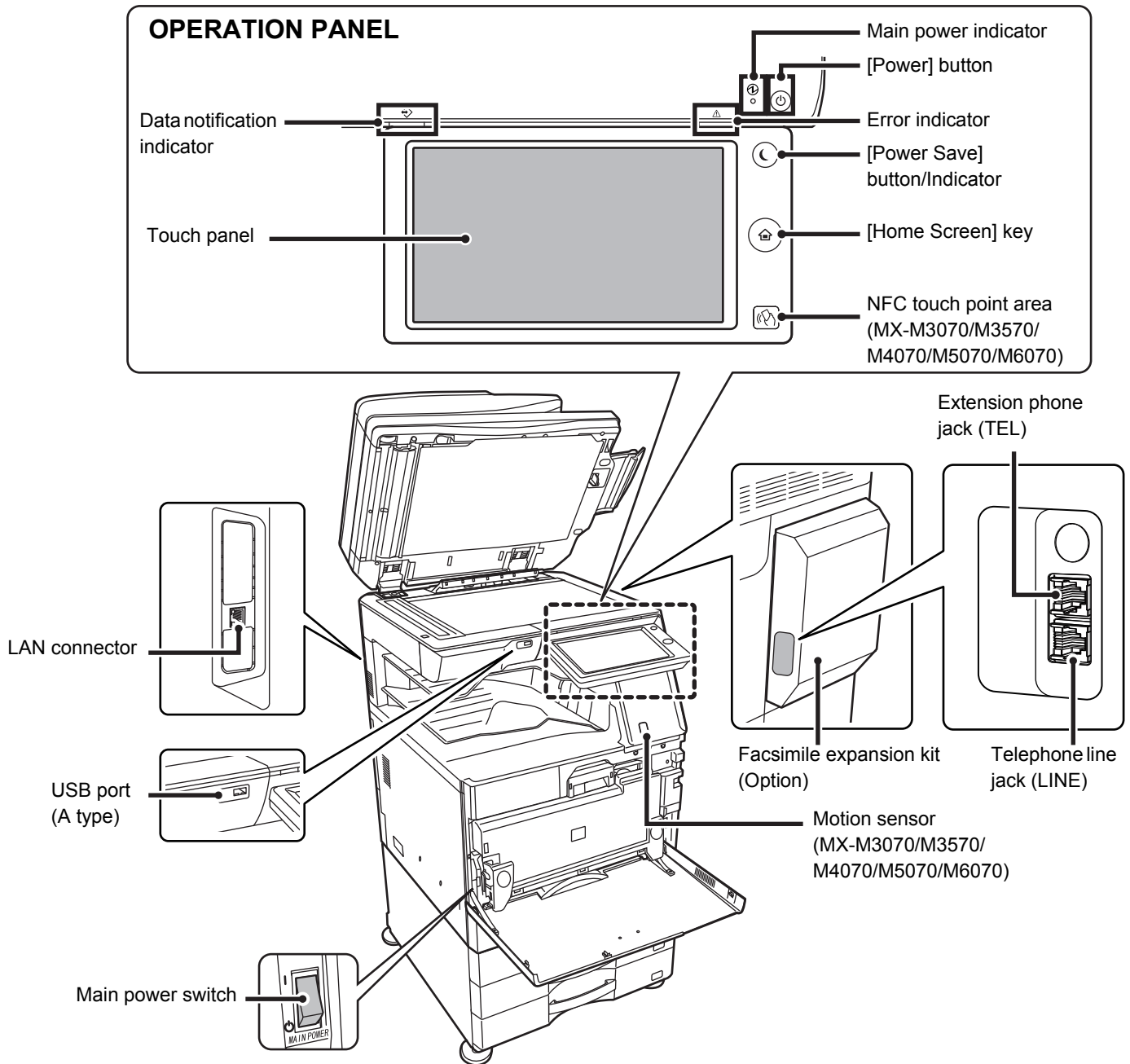



Placing the original and adding paper

Is the original placed correctly?

●Automatic Document Feeder

Do not exceed the indicator line

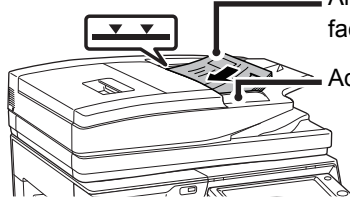

Align the edges and place face up Insert all the way in

Adjust to the original size

If the original has a fold, straighten the fold before placing. (This prevents original misfeeds and incorrect detection of the original size)

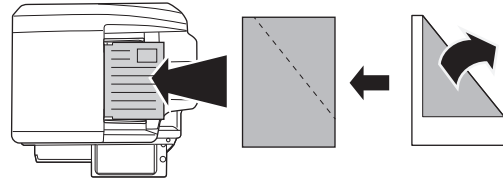

If the original is stapled, be sure to remove the staples and fan the pages well before placing. (This is to prevent misfeeding and tearing of the original, and to prevent torn fragments of the original from remaining in the feeder.)

●Document glass

Place the original in the back left corner. If the original has a fold, straighten the fold before placing. (This prevents original misfeeds and incorrect detection of the original size)

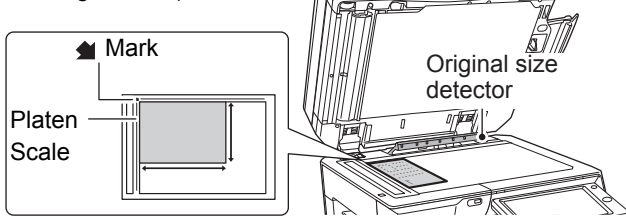

Is the paper loaded correctly?

●Paper tray

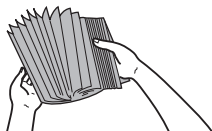

Fan the paper well before loading it.

Set the guides to the size of the paper.

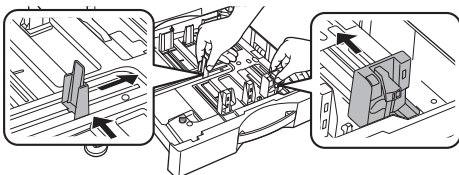

The paper must not exceed the maximum number of sheets and must not be higher than the indicator line.

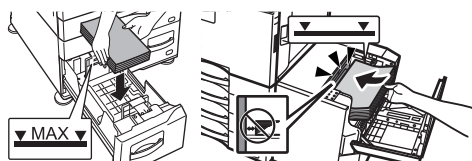
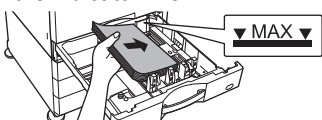

●Bypass tray

Pull the extension guide all the way out. (A4R (8-1/2 x 11"R) or more)

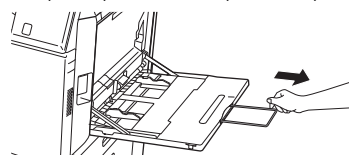

Adjust the bypass tray guides so that they slightly contact the loaded paper.

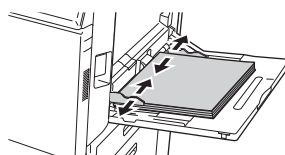

Load the paper with the print side facing down.

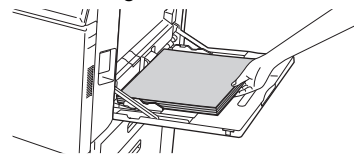

The paper must not exceed the maximum number of sheets and must not be higher than the indicator line.

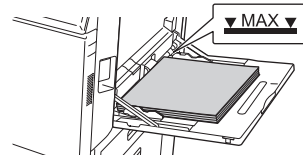



Maintenance

How to clean the automatic document feeder and document glass

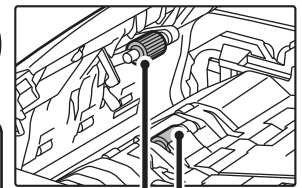
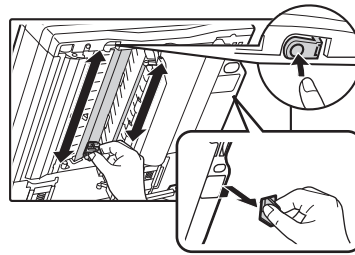
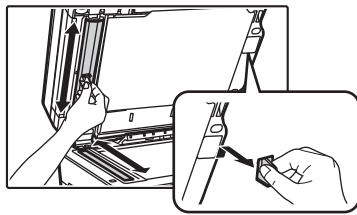
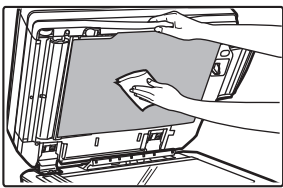

Paper feed roller

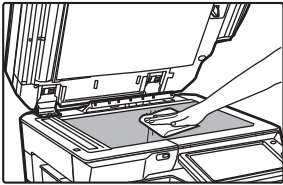

In a duplex single pass feeder (DSPF)

In a reversing single pass feeder (RSPF)

Removing a toner cartridge

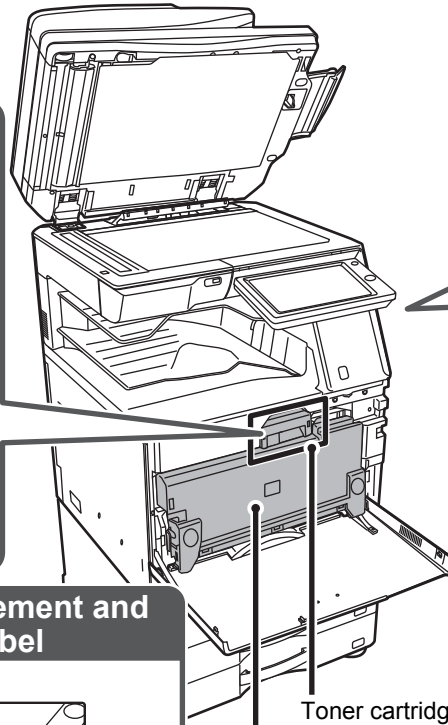
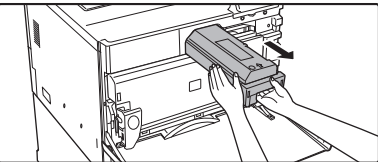
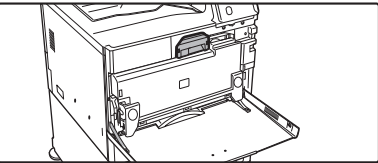

Toner cartridge
Waste toner box

How to clean the bypass feed roller

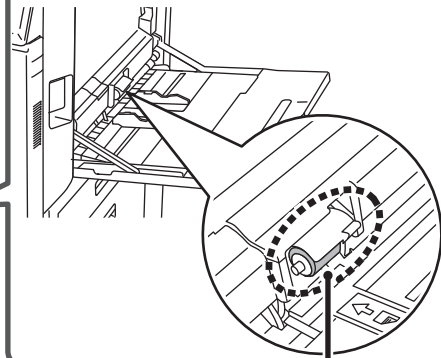

Bypass feed roller

Position of staple replacement and staple jam explanation label

● Inner finisher

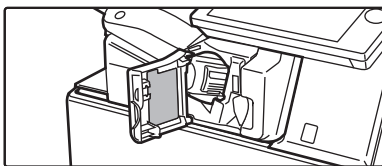

● Finisher

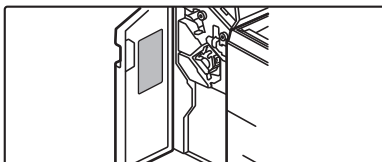

● Saddle stitch finisher/Saddle Stitch Finisher (large stacker)

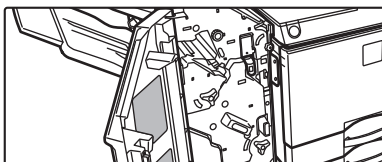

Discarding punch waste

● Inner finisher

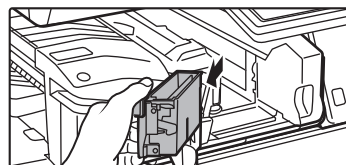

● Finisher

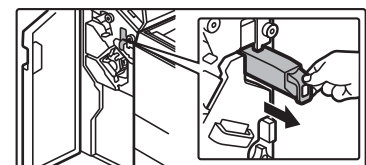

● Saddle stitch finisher/Saddle Stitch Finisher (large stacker)

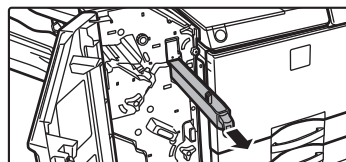



CHECK LIST

Problem	Check	Page
I CAN'T USE A PARTICULAR FUNCTION OR PERIPHERAL DEVICE	Have functions been disabled by the administrator?	10
I DON'T KNOW HOW TO CHECK THE TOTAL NUMBER OF PAGES USED	Hold down the [Home Screen] key.	10
	You can check in the status of setting mode.	10
THE OPERATION PANEL CANNOT BE USED	Is the main power indicator lit?	10
	Did you just power on the machine?	10
	Is the [Power Save Mode] button blinking?	10
	Is a cover open or a device separated from the machine?	10
	Did login fail three times in a row?	11
	Does a message appear indicating that Auto Login failed?	11
	Does the message "Call for service. Code:xx-xx*." appear in the touch panel?	11
THE MOTION SENSOR DOES NOT RESPOND CORRECTLY (MX-M3070/M3570/M4070/M5070/M6070)	Is the motion sensor disabled?	11
	Is there are problem in the installation location or installation environment?	11
	Is the detection range set correctly?	12
IT IS DIFFICUIT OR IMPOSSIBLE TO HEAR THE VOICE ASSIST FUNCTION	Is the voice assist function enabled?	12
	Is the installation location suitable?	12
	Is the volume of the voice assist function correctly adjusted?	12
PRINTING IS NOT POSSIBLE OR STOPS DURING A JOB	Is a tray out of paper?	13
	Is the machine out of toner?	13
	Has a paper misfeed occurred?	13
	Is the output tray full?	13
	Is the waste toner box full?	13
	Are restrictions placed on the trays that can be used in each mode (copy, print, image send, and document filing)?	13
THE ORIGINAL SIZE IS NOT AUTOMATICALLY SELECTED OR THE WRONG SIZE IS SELECTED	Is the original curled or folded?	13
	Did you place an original smaller than A5 (5-1/2" x 8-1/2") size?	13
THE DISPLAYED BYPASS TRAY PAPER SIZE IS NOT CORRECT	Do the bypass tray guides match the width of the loaded paper?	13
THE ORIGINAL MISFEEDS (AUTOMATIC DOCUMENT FEEDER)	Is too much paper loaded into the document feeder tray?	14
	Is the original a long original?	14
	Is the original on thin paper?	14
	Is the feed roller dirty? (In a reversing single pass feeder (RSPF))	14
THE PAPER MISFEEDS	Is a torn piece of paper remaining in the machine?	14
	Is too much paper loaded in the tray?	14
	Are multiple sheets feeding at once?	14
	Are you using paper that is not within the specifications?	14
	Are the bypass tray guides adjusted to the width of the paper?	14
	Is the bypass tray extension guide pulled out?	14
	Is the bypass feed roller dirty?	14
	Is A5 (5-1/2" x 8-1/2") size paper loaded?	14
	Is the paper size specified?	15
	Did you add paper to the bypass tray?	15
	Are you using punched paper?	15
	Are you using label sheets that cannot be used?	15
	Remove the paper, turn it over, and reload it. Using a different paper type may solve the problem.	15



? Problem	✓ Check	Page
PAPER DOES NOT FEED FROM THE PAPER TRAY	Is the paper loaded correctly into the paper tray?	15
	Has the tray been prohibited in some modes (copy, print, fax, image send, document filing)?	15
I DON'T KNOW HOW TO CHANGE THE PAPER SIZE	Set the paper size used in each tray in the tray settings.	15
THE OUTPUT IS NOTICEABLY CURLED AND UNEVEN	Remove the paper, turn it over, and reload it. Using a different paper type may solve the problem.	16
THE IMAGE IS SKEWED ON THE PAPER	Is too much paper loaded into the bypass tray?	16
	Are the bypass tray guides adjusted to the width of the paper?	16
	Are the original guides adjusted to the width of the paper?	16
	Are you scanning originals of mixed width? (In a reversing single pass feeder (RSPF))	16
LINES APPEAR IN THE SCANNED IMAGE	Are the scanning areas of the document glass or automatic document feeder dirty?	17
	Is the bypass feed roller dirty?	17
	Did you clean the main charger of the photoconductive drum?	17
SMUDGES APPEAR ON PRINTED OUTPUT	Are you using paper that is not within the specifications?	17
	Are you printing on pre-punched paper?	17
	Does a message appear indicating the need for maintenance?	17
	Remove the paper, turn it over, and reload it. Using a different paper type may solve the problem.	17
WHEN PRINTING ON THICK PAPER, THE PRINT RESULT IS DIRTY FROM THE 2ND PAGE ON	Has the paper type been set correctly?	18
I DON'T KNOW HOW TO CHANGE THE OUTPUT TRAY	Did you change the output tray?	18
PART OF THE IMAGE IS CUT OFF	Has the correct paper size been set?	18
	Was the original placed in the correct position?	18
PRINTING TAKES PLACE ON THE WRONG SIDE OF THE PAPER	Is the paper loaded with the print side facing in the correct direction?	19
A COVER OR INSERT IS NOT PRINTED ON THE SPECIFIED PAPER	Has the paper type been set correctly?	19
THE CONNECTED USB DEVICE CANNOT BE USED	Is the USB device compatible with the machine?	19
	Is the connected USB device recognized correctly?	19
	Is the format of the USB memory device FAT32?	19
	Are you using a USB memory device with a capacity of more than 32 GB?	19
THE FINISHER/SADDLE FINISHER DOES NOT OPERATE	Does a message appear indicating that you need to remove paper from the stapler compiler?	20
	Have functions been disabled by the administrator?	20
STAPLING DOES NOT TAKE PLACE (INCLUDING SADDLE STITCH)	Does a message appear instructing you to check the staple unit?	20
	Does a message appear instructing you to add staples?	20
	Is a different width of paper mixed in?	20
	Are there more sheets than can be stapled at once?	20
	Is a paper size that cannot be stapled included in the print job?	20
	Is the paper type setting of the tray selected in the printer driver set to a paper type that cannot be stapled?	20
	Does a message appear instructing you to check the punch module?	21
PUNCHING DOES NOT TAKE PLACE	Is a different size of paper mixed in?	21
	Is a paper size that cannot be punched included in the print job?	21
	Is the tray selected in the printer driver set to a paper type that cannot be punched?	21



? Problem	✓ Check	Page
THE STAPLING POSITION OR PUNCH POSITION IS NOT CORRECT	Is the stapling position setting correctly? Are the punching positions setting correctly?	21 21
FOLDING DOES NOT TAKE PLACE	Did the administrator enable the [Disabling of Duplex] setting? Are you using a paper type that has a specific front and reverse side?	21 21
PREVIEW IMAGES OR THUMBNAIL IMAGES DO NOT APPEAR	Are there a number of jobs waiting to be executed?	22
THE TOUCH PANEL DISPLAY IS DIFFICULT TO VIEW	Is the brightness properly adjusted?	22
YOU WERE LOGGED OUT WITHOUT LOGGING OUT YOURSELF	Did Auto Clear activate?	22
I DON'T KNOW WHERE THE IP ADDRESS SETTING IS	The IP address is set in the Network Settings of Setting mode.	22
I DON'T KNOW HOW TO CHANGE THE BACKGROUND COLOR OF THE HOME SCREEN	You can change the background color in "MFP Display Pattern Setting".	23
I DON'T KNOW HOW TO ADD A SHORTCUT TO OR DELETE A SHORTCUT FROM THE HOME SCREEN	You can change a shortcut in "Edit Home".	23
I DON'T KNOW HOW TO RESTORE THE LARGE TEXT SETTING TO ITS ORIGINAL STATE	Is large text mode enabled in the home screen?	23
I DON'T KNOW HOW TO ADJUST THE TIME THE MACHINE ENTERS ENERGY SAVE MODE	Set the time the machine enters energy save mode in the Energy Save settings of setting mode.	24
I FORGOT THE ADMINISTRATOR PASSWORD	Was the administrator password changed from the factory default setting?	24
I DON'T KNOW WHOM TO CONTACT FOR MAINTENANCE AND SERVICE	Please check the customer support information.	24



I CAN'T USE A PARTICULAR FUNCTION OR PERIPHERAL DEVICE



Check

Have functions been disabled by the administrator?



Solution

- Check with your administrator. Some functions may have been disabled in the setting mode. When user authentication is enabled, the functions that you can use may be restricted in your user settings.



I DON'T KNOW HOW TO CHECK THE TOTAL NUMBER OF PAGES USED



Check

Hold down the [Home Screen] key.

You can check in the status of setting mode.



Solution

- When you hold down the [Home Screen] key, a message showing the total page usage and toner level will appear.
- [Total Count] appears in the [Status] of setting mode. You can check the total pages used from this item.



THE OPERATION PANEL CANNOT BE USED



Check

Is the main power indicator lit?

Did you just power on the machine?

Is the [Power Save Mode] button blinking?

Is a cover open or a device separated from the machine?



Solution

- If the main power indicator is not lit up, turn the machine's power on. Make sure that the power plug is firmly inserted in the power outlet, switch the main power switch to the " I " position.
- Wait until a message appears indicating that the machine is ready. After the [Power] button is turned on, the machine requires some time to complete warmup operation. During warmup operation, functions can be selected, but a job cannot be run.
- Auto Power Shut-Off mode has activated. To return the machine to normal operation, press the [Power Save Mode] button. For more information, see the "User's Manual" .
- Read the message and take appropriate actions. A warning message will appear when a cover is open or a device is separated from the machine.



Check



Solution

Did login fail three times in a row?

- After operation unlocks, log in using the correct user information.
When [A Warning when Login Fails] is enabled in the setting mode and login fails 3 times in a row, a warning will be displayed and user authentication operation will lock for 5 minutes.
(If you do not know your user information, contact your administrator.)
⇒ "Settings" → [User Control] → [Default Settings]
→ [A Warning when Login Fails]

Does a message appear indicating that Auto Login failed?

- Check with your administrator.
Auto Login failed due to network or other problems. If you are the administrator, tap the [Administrator Password] key, log in as an administrator, and temporarily change the auto login settings in the setting mode. (Restore the changed settings to their original state after the problems have been solved.)

**Does the message "Call for service. Code:xx-xx*" appear in the touch panel?
*Letters and numbers appear in xx-xx.**

- Turn on the machine power again.
- Make sure that the background color of the job status display at the upper right corner of the touch panel is gray, and press the [Power] button and then turn the main power switch to the "⏻" position. Waiting at least 10 seconds and then turn the main power switch to the "⏻" position.
- If the message still appears after switching the [Power] button and the main power switch off and on several times, it is likely that a failure has occurred that requires service. In this event, stop using the machine, unplug the power plug, and contact your dealer or nearest SHARP Service Department. (When contacting your dealer or nearest SHARP Service Department, inform them of the displayed error code.)



THE MOTION SENSOR DOES NOT RESPOND CORRECTLY (MX-M3070/M3570/M4070/M5070/M6070)



Check



Solution

Is the motion sensor disabled?

- Select [Motion Sensor Mode] in "Settings (administrator)" - [System Settings]→[Energy Save]→[Eco Setting]→[Sleep Mode Power Level] or "Settings (administrator)" - [Initial Installation Settings]→[Sleep Mode Power Level].

Is there are problem in the installation location or installation environment?

- Check the installation location and installation environment.
The motion sensor may not operate correctly in the conditions below.
 - An object is in front of the motion sensor
 - There are scratches or dirt on the motion sensor cover
 - The motion sensor is directly exposed to sunlight or air flow
 - The motion sensor is damaged
 - There is a source of heat such as a heater nearby
 - An object is moving in the detection range



Check

Is the detection range set correctly?



Solution

■ Adjust the detection range.

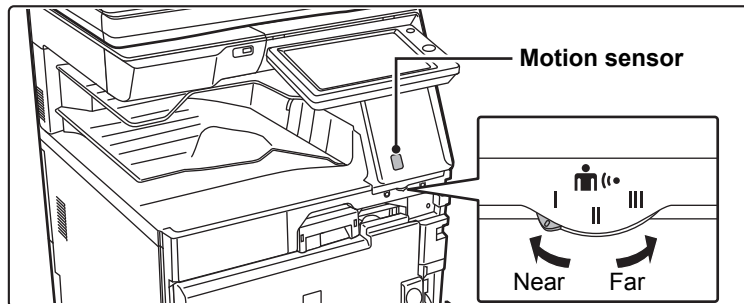

IT IS DIFFICULT OR IMPOSSIBLE TO HEAR THE VOICE ASSIST FUNCTION

(This function is not available in North America.)



Check

Is the voice assist function enabled?



Solution

■ Set the voice assist function to [Enable].
⇒ "Settings (administrator)" → [System Settings] → [Common Settings] → [Voice Assist Settings] → [Voice Assist Function].

Is the installation location suitable?

■ To make the voice function sufficiently audible, install the machine with its back side against a wall.

Is the volume of the voice assist function correctly adjusted?

■ Tap [Volume] on the Home screen and adjust the volume. When the voice assist function is set to [Disable], [Volume] does not appear.



PRINTING IS NOT POSSIBLE OR STOPS DURING A JOB



Check

Is a tray out of paper?

Is the machine out of toner?

Has a paper misfeed occurred?

Is the output tray full?

Is the waste toner box full?

Are restrictions placed on the trays that can be used in each mode (copy, print, image send, and document filing)?



Solution

■ Add paper as instructed by the message in the touch panel.

■ Replace the toner cartridge.
■ [Maintenance \(page 6\)](#)

■ Remove the misfeed as instructed by the message in the touch panel.

■ Remove the output from the tray and resume printing.
When the output tray becomes full, a detector activates and stops printing.

■ Replace the waste toner box as instructed by the message in the touch panel.

■ Check the settings in [Paper Tray Settings] and see if checkmarks appear in the checkboxes of each mode ([Feeding Approved Job]).
Functions without a checkmark cannot be used for printing using that tray.
⇒ "Settings" → [System Settings] → [Common Settings] → [Paper Settings] → [Paper Tray Settings] → [Tray Registration] → [Feeding Approved Job]



THE ORIGINAL SIZE IS NOT AUTOMATICALLY SELECTED OR THE WRONG SIZE IS SELECTED



Check

Is the original curled or folded?

Did you place an original smaller than A5 (5-1/2" x 8-1/2") size?



Solution

■ Straighten the original.
The correct original size cannot be detected if the original is curled or folded.

■ Select the original size manually.
Original sizes smaller than A5 (5-1/2" x 8-1/2") cannot be detected. When scanning a small original on the document glass, it is convenient to place a blank sheet of paper on top of the original which is the same size (A4 (8-1/2" x 11"), B5 (8-1/2" x 11"R), etc.) as the paper that you wish to use for printing.



THE DISPLAYED BYPASS TRAY PAPER SIZE IS NOT CORRECT



Check

Do the bypass tray guides match the width of the loaded paper?



Solution

■ Set the bypass tray guides to the width of the paper.
When loading paper in the bypass tray, be sure to pull out the extension guide to enable the paper size to be detected correctly.



THE ORIGINAL MISFEEDS (AUTOMATIC DOCUMENT FEEDER)



Check

Is too much paper loaded into the document feeder tray?

Is the original a long original?

Is the original on thin paper?

Is the feed roller dirty?
(In a reversing single pass feeder (RSPF))



Solution

■ Make sure that the stack of paper in the tray is not higher than the indicator line.
▶ [Placing the original and adding paper \(page 5\)](#)

■ When using the automatic document feeder to scan a long original, set the scan size to [Long Size].
(Note that long originals cannot be copied using the copy function.)

■ Use the document glass to scan the original.
If you need to use the automatic document feeder, use [Slow Scan Mode] in [Others] to scan the original.

■ Clean the surface of the paper feed roller.
▶ [Maintenance \(page 6\)](#)



THE PAPER MISFEEDS



Check

Is a torn piece of paper remaining in the machine?

Is too much paper loaded in the tray?

Are multiple sheets feeding at once?

Are you using paper that is not within the specifications?

Are the bypass tray guides adjusted to the width of the paper?

Is the bypass tray extension guide pulled out?

Is the bypass feed roller dirty?

Is A5 (5-1/2" x 8-1/2") size paper loaded?



Solution

■ Follow the instructions in the touch panel to remove all paper.

■ Reload the paper. Load no more than the maximum number of sheets and do not exceed the indicator line.
▶ [Placing the original and adding paper \(page 5\)](#)

■ Fan the paper well before loading it.

■ Use SHARP-recommended paper.
Using paper that is for other models or special paper that is not supported may result in misfeeds, creases, or smudges.
⇒ - "SUPPLIES" in Start Guide
For paper that is prohibited or not recommended, see User's Manual.

■ Adjust the bypass tray guides to the width of the paper so that they slightly contact the sides of the paper.
▶ [Placing the original and adding paper \(page 5\)](#)

■ When loading large-size paper, pull out the extension guide.
▶ [Placing the original and adding paper \(page 5\)](#)

■ Clean the surface of the bypass feed roller.
▶ [Maintenance \(page 6\)](#)

■ When loading A5 (5-1/2" x 8-1/2") size paper, place the paper in the horizontal (A5R (5-1/2" x 8-1/2"R)) orientation. (Excluding tray 1 and the bypass tray)



Check

Is the paper size specified?



Solution

- If you are using a non-standard size, be sure to specify the paper size. If the size of paper loaded into a tray was changed, be sure to check the paper size setting.
⇒ "Settings" → [System Settings] → [Common Settings] → [Paper Settings] → [Paper Tray Settings] → [Tray Registration]

Did you add paper to the bypass tray?

- When adding paper, remove any paper remaining in the bypass tray, combine it with the paper to be added, and reload as a single stack. If paper is added without removing the remaining paper, a misfeed may occur.

Are you using punched paper?

- When using punched paper, set the paper type to punched.
⇒ "Settings" → [System Settings] → [Common Settings] → [Paper Settings] → [Paper Tray Settings] → [Tray Registration]

Are you using label sheets that cannot be used?

- Labels without a carrier sheet may stick to the transfer surface and cause a misfeed.

Remove the paper, turn it over, and reload it. Using a different paper type may solve the problem.

- This may improve some states of paper curling.
▶ [Placing the original and adding paper \(page 5\)](#)



PAPER DOES NOT FEED FROM THE PAPER TRAY



Check

Is the paper loaded correctly into the paper tray?



Solution

- Set the guides to the size of the paper. Reload the paper. Load no more than the maximum number of sheets and do not exceed the indicator line.
▶ [Placing the original and adding paper \(page 5\)](#)

Has the tray been prohibited in some modes (copy, print, fax, image send, document filing)?

- Check the settings in [Paper Tray Settings] and see if checkmarks appear in the checkboxes of each mode ([Feeding Approved Job]). Functions without a checkmark cannot be used for printing using that tray.
⇒ "Settings" → [System Settings] → [Common Settings] → [Paper Settings] → [Paper Tray Settings] → [Tray Registration] → [Feeding Approved Job]



I DON'T KNOW HOW TO CHANGE THE PAPER SIZE



Check

Set the paper size used in each tray in the tray settings.



Solution

- The "Tray Settings" key can be found in the home screen. Tap this key to display the tray settings screen. Tap the tray whose paper size you want to change, select the paper type, and then tap the [Size] tab. Select the paper size and tap the [OK] key. If you loaded a special size of paper in the bypass tray, tap the [Direct Entry] key after tapping the [Size] tab, enter the paper size manually, and tap the [Execute] key.



THE OUTPUT IS NOTICEABLY CURLED AND UNEVEN



Check

Remove the paper, turn it over, and reload it. Using a different paper type may solve the problem.



Solution

- This may improve some states of paper curling.
 - ▶ [Placing the original and adding paper \(page 5\)](#)



THE IMAGE IS SKEWED ON THE PAPER



Check

Is too much paper loaded into the bypass tray?

Are the bypass tray guides adjusted to the width of the paper?

Are the original guides adjusted to the width of the paper?

Are you scanning originals of mixed width? (In a reversing single pass feeder (RSPF))



Solution

- Reload the paper. Load no more than the maximum number of sheets and do not exceed the indicator line.
The maximum number of sheets varies depending on the paper type setting.
- Adjust the bypass tray guides to the width of the paper so that they slightly contact the sides of the paper.
- Adjust the original guides to the width of the paper.
- If the printed image is skewed when you have scanned originals of mixed width, open the document feeder cover, change the switch position, and place the originals.
The A position of the switch is for normal scanning. The B position is for scanning of mixed originals.
Be sure to set the switch back to the A position after the mixed original job is finished.

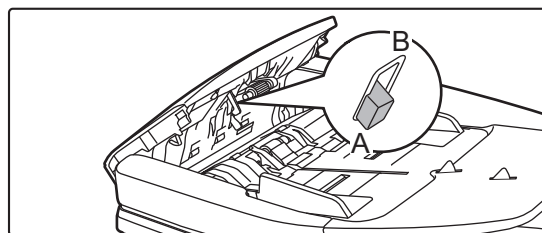



LINES APPEAR IN THE SCANNED IMAGE



Check

Are the scanning areas of the document glass or automatic document feeder dirty?

Is the bypass feed roller dirty?

Did you clean the main charger of the photoconductive drum?



Solution

■ Clean the scanning areas of the document glass or automatic document feeder.
▶ [Maintenance \(page 6\)](#)

■ Clean the surface of the bypass feed roller.
▶ [Maintenance \(page 6\)](#)

■ Clean the main charger of the photoconductive drum. For details on cleaning, refer to the User's Manual.



SMUDGES APPEAR ON PRINTED OUTPUT



Check

Are you using paper that is not within the specifications?

Are you printing on pre-punched paper?

Does a message appear indicating the need for maintenance?

Remove the paper, turn it over, and reload it. Using a different paper type may solve the problem.



Solution

■ Use SHARP-recommended paper.
Using paper that is for other models or special paper that is not supported may result in misfeeds, creases, or smudges.
⇒ - "SUPPLIES" in Start Guide

■ Take care that the image does not overlap the punch holes.
If the printed image overlaps the punch holes, smudges may appear on the reverse side of the paper following 1-sided printing, or on both sides following 2-sided printing.

■ Contact your dealer or nearest SHARP Service Department as soon as possible.

■ This may improve some states of paper curling.
▶ [Placing the original and adding paper \(page 5\)](#)



WHEN PRINTING ON THICK PAPER, THE PRINT RESULT IS DIRTY FROM THE 2ND PAGE ON



Check

Has the paper type been set correctly?



Solution

- Set the correct paper type in the tray settings. Make sure that the following did not occur:
 - When using heavy paper, change the paper type in the tray settings to Heavy. (The image may disappear if rubbed.)
 - Paper other than heavy paper is being used, but heavy paper is selected in the tray settings. (This may cause creases and misfeeds.)
- ⇒ "Settings" → [System Settings] → [Common Settings] → [Paper Settings] → [Paper Tray Settings] → [Tray Registration]



I DON'T KNOW HOW TO CHANGE THE OUTPUT TRAY



Check

Did you change the output tray?



Solution

- When copying, you can select the output tray in normal mode. Tap [Sort/Group] or [Staple Sort] in the base screen of normal mode. Or, tap [Others] in the base screen of normal mode and tap [Output Tray]. You can set the output tray in these screens.
When printing, you can select the output tray in the printer driver. Click the [Finishing] tab in the printer driver, and select the output tray in [Output Tray]. The output tray is fixed and cannot be changed when some copy or print settings are selected. Some copy or print settings may be canceled when you change the output tray.



PART OF THE IMAGE IS CUT OFF



Check

Has the correct paper size been set?



Solution

- If you are using a non-standard size, be sure to specify the paper size. If the size of paper loaded into a tray was changed, be sure to check the paper size setting.
⇒ "Settings" → [System Settings] → [Common Settings] → [Paper Settings] → [Paper Tray Settings] → [Tray Registration]

Was the original placed in the correct position?

- If you are using the document glass, be sure to place the original in the far left corner of the document glass.
▶ [Placing the original and adding paper \(page 5\)](#)



PRINTING TAKES PLACE ON THE WRONG SIDE OF THE PAPER



Check

Is the paper loaded with the print side facing in the correct direction?



Solution

- Make sure that the print side of paper is facing in the correct direction.
 - Trays 1 to 4:
Place the paper with the print side face up.*
 - Bypass Tray, Tray 5:
Place the paper with the print side face down.*
- * When the paper type is "Pre-Printed" or "Letter Head", load the paper in the opposite way.
(Except when [Disabling of Duplex] is enabled in the setting mode (administrator).
For information about the setting mode, consult your administrator.)



A COVER OR INSERT IS NOT PRINTED ON THE SPECIFIED PAPER



Check

Has the paper type been set correctly?



Solution

- Set the correct paper type for the tray that contains the paper specified for the cover or insert.
If the paper type set for the cover or insert is not the same as the paper type set for the tray, paper will be fed from a different tray.
⇒ "Settings" → [System Settings] → [Common Settings] → [Paper Settings] → [Paper Tray Settings] → [Tray Registration]



THE CONNECTED USB DEVICE CANNOT BE USED



Check

Is the USB device compatible with the machine?



Solution

Is the connected USB device recognized correctly?

- Ask your dealer if the device is compatible with the machine.
USB devices that are not compatible with the machine cannot be used.
- When a USB device is connected to the machine and correctly recognized, an icon () will appear at the top of the touch panel. If it is not recognized, connect it once again.
- Check the file format of the USB memory device.
If the format of the USB memory device is other than FAT32, use your PC to change the format to FAT32.

Is the format of the USB memory device FAT32?

Are you using a USB memory device with a capacity of more than 32 GB?

- Use a 32 GB or less USB memory device.



THE FINISHER/SADDLE FINISHER DOES NOT OPERATE



Check

Does a message appear indicating that you need to remove paper from the stapler compiler?

Have functions been disabled by the administrator?



Solution

■ Remove all remaining paper from the stapler compiler.

■ Check with your administrator. Some functions may have been disabled in the setting mode.



STAPLING DOES NOT TAKE PLACE (INCLUDING SADDLE STITCH)



Check

Does a message appear instructing you to check the staple unit?

Does a message appear instructing you to add staples?

Is a different width of paper mixed in?

Are there more sheets than can be stapled at once?

Is a paper size that cannot be stapled included in the print job?

Is the paper type setting of the tray selected in the printer driver set to a paper type that cannot be stapled?



Solution

■ Remove jammed staples.
▶ [Maintenance \(page 6\)](#)

■ Replace the staple cartridge. Do not forget to replace the staple case.
▶ [Maintenance \(page 6\)](#)

■ To perform mixed size stapling, using paper of the same width and select the [Same Width] setting. Stapling is not possible when paper of different widths are mixed together. When copying, select [Same Width] for [Mixed Size Original] in [Others].

■ For the maximum number of sheets that can be stapled, see "SPECIFICATIONS" in Start Guide.

■ For paper sizes that can be stapled, see "SPECIFICATIONS" in Start Guide.

■ You must check the paper types that are set on the machine, and select a paper tray that is set to paper* that can be used for staple printing. Click the [Tray Status] button in [Paper Source] tab of the printer properties window and check the paper type setting of each tray.
*Stapling is not possible on labels, tab paper, glossy paper, transparency film, or envelopes. In addition, if "Disable Staple" is selected in the user type, stapling will not be possible.



PUNCHING DOES NOT TAKE PLACE



Check

Does a message appear instructing you to check the punch module?

Is a different size of paper mixed in?

Is a paper size that cannot be punched included in the print job?

Is the tray selected in the printer driver set to a paper type that cannot be punched?



Solution

■ Dispose of punch scraps.
▶ [Maintenance \(page 6\)](#)

■ Punching is not possible when different widths of paper are mixed together. To perform mixed size punching, use paper of the same width and select the [Same Width] setting. When copying, select [Same Width] for [Mixed Size Original] in [Others].

■ For the paper sizes that can be punched, see "SPECIFICATIONS" in Start Guide.

■ Check the paper type settings in the machine and select a tray that has paper that can be used for punching*. Click the [Tray Status] button in [Paper Source] tab of the printer properties window and check the paper type setting of each tray.
*Punching is not possible on labels, tab paper, glossy paper, transparency film, and envelopes. In addition, if "Disable Punch" is selected in the user type, punching will not be possible.



THE STAPLING POSITION OR PUNCH POSITION IS NOT CORRECT



Check

Is the stapling position setting correctly?

Are the punching positions setting correctly?



Solution

■ Check the stapling position in "PREVIEW SCREEN".

■ Check the punch position in "PREVIEW SCREEN".



FOLDING DOES NOT TAKE PLACE



Check

Did the administrator enable the [Disabling of Duplex] setting?

Are you using a paper type that has a specific front and reverse side?



Solution

■ The paper folding function cannot be used when [Disabling of Duplex] is enabled in the setting mode. Check with your administrator.
⇒ In "Settings (administrator)", [System Settings] → [Common Settings] → [Device Control] → [Disabling of Duplex].

■ The folding function cannot be used with pre-printed paper, letterhead paper, or other paper that has specific front or reverse sides. When folding paper, use a paper type such as plain paper that does not have specific front or reverse sides.



PREVIEW IMAGES OR THUMBNAIL IMAGES DO NOT APPEAR



Check

Are there a number of jobs waiting to be executed?



Solution

■ Wait until several of the jobs have been executed.



THE TOUCH PANEL DISPLAY IS DIFFICULT TO VIEW



Check

Is the brightness properly adjusted?



Solution

■ Tap the [LCD Control] key () on the home screen to adjust the brightness.



YOU WERE LOGGED OUT WITHOUT LOGGING OUT YOURSELF



Check

Did Auto Clear activate?



Solution

■ When user authentication is used, the currently logged in user will be automatically logged out if Auto Clear activates. Log in again.
If you are the administrator, change the time setting of Auto Clear or disable Auto Clear in [Auto Clear Setting].
⇒ "Settings (administrator)" → [System Settings] → [Common Settings] → [Operation Settings] → [Condition Settings] → [Auto Clear Setting]



I DON'T KNOW WHERE THE IP ADDRESS SETTING IS



Check

The IP address is set in the Network Settings of Setting mode.



Solution

■ To set a permanent IP address, ask your network administrator for the IP address assigned to the machine and other information necessary for the Network Settings.
⇒ "Settings (administrator)" → [System Settings] → [Network Settings] → [Protocol Settings]



I DON'T KNOW HOW TO CHANGE THE BACKGROUND COLOR OF THE HOME SCREEN



Check

You can change the background color in "MFP Display Pattern Setting".



Solution

- Open the action panel on the home screen and tap [MFP Display Pattern Setting]. Enter the administrator password, and select the desired color from patterns 1 to 5. For more information, see the U/I Customize Guide.



I DON'T KNOW HOW TO ADD A SHORTCUT TO OR DELETE A SHORTCUT FROM THE HOME SCREEN



Check

You can change a shortcut in "Edit Home".



Solution

- Open the action panel on the home screen and tap [Edit Home]. Enter the administrator password, tap the desired location and add a shortcut, or tap a shortcut and delete. For more information, see the U/I Customize Guide.



I DON'T KNOW HOW TO RESTORE THE LARGE TEXT SETTING TO ITS ORIGINAL STATE





Check

Is large text mode enabled in the home screen?



Solution

- If the large text mode icon is  , large text mode is enabled. Tap the large text mode icon to change it to  and cancel large text mode.



I DON'T KNOW HOW TO ADJUST THE TIME THE MACHINE ENTERS ENERGY SAVE MODE



Check

Set the time the machine enters energy save mode in the Energy Save settings of setting mode.



Solution

- Set the time the machine enters energy save mode in the Energy Save settings of setting mode.
Set the time the machine enters Preheat Mode.
⇒ "Settings (administrator)" → [System Settings] → [Energy Save] → [Eco Setting] → [Preheat Mode Setting]
- Set the time that Auto Power Shut-Off takes place
⇒ "Settings (administrator)" → [System Settings] → [Energy Save] → [Eco Setting] → [Auto Power Shut-Off] → [Auto Power Shut-Off Timer]



I FORGOT THE ADMINISTRATOR PASSWORD



Check

Was the administrator password changed from the factory default setting?



Solution

- Contact your dealer or nearest SHARP Service Department.
For the factory default administrator password, see "TO THE ADMINISTRATOR OF THE MACHINE" in Start Guide. After changing the password, take special care to remember it.



I DON'T KNOW WHOM TO CONTACT FOR MAINTENANCE AND SERVICE



Check

Please check the customer support information.



Solution

- Contact your dealer or nearest SHARP Service Department.



CHECK LIST

Have functions been disabled by the administrator?

Some functions may have been disabled in the setting mode. When user authentication is enabled, the functions that you can use may be restricted in your user settings. Check with your administrator.

? Problem	✓ Check	Page
2-SIDED COPYING DOES NOT TAKE PLACE	Does the paper type setting of the selected tray specify a type of paper that cannot be used for 2-sided copying?	26
	Are you using a special size or type of paper?	26
	Are you copying using settings that do not allow 2-sided copying?	26
ROTATE COPY DOES NOT WORK	Did you select the copy ratio manually?	26
	Are you copying using settings that do not allow rotate copying?	26
	Is "Rotation Copy Setting" disabled in the setting mode?	26
ENLARGE/REDUCE DOES NOT WORK	Are the original, paper, and ratio settings correct?	26
THE IMAGE IS TOO LIGHT OR TOO DARK	Is the image too light?	27
	Is the image too dark?	27
	Has an appropriate exposure mode for the original type been selected?	27
	Is the overall copy density too light?	27
PART OF THE IMAGE IS CUT OFF	Has an appropriate ratio been selected for the original size and paper size?	28
	Are you using an AB (inch) size original?	28
COPIES COME OUT BLANK	Is the original placed face up or face down correctly?	28
I WANT TO COPY MULTIPLE A4 PAGES ONTO ONE A4 SHEET OF PAPER	Use N-Up.	28



2-SIDED COPYING DOES NOT TAKE PLACE



Check

Does the paper type setting of the selected tray specify a type of paper that cannot be used for 2-sided copying?

Are you using a special size or type of paper?

Are you copying using settings that do not allow 2-sided copying?



Solution

- Check "Paper Tray Settings" in the setting mode.
⇒ "Settings" → [System Settings] → [Common Settings] → [Paper Settings] → [Paper Tray Settings] → [Tray Registration] → [Feeding Approved Job]
Check the [Tray Settings] in the home screen.
Tap the selected tray, and in the screen that appears, tap the [Paper Property] key.
If the [Disable Duplex] checkbox in the paper properties screen is , the tray cannot be used for duplex printing. Change the paper type to a type that can be used for duplex printing.

- For the paper types and sizes that can be used for two-sided copying, read "SPECIFICATIONS" in Start Guide.

- 2-Sided Copy can generally be combined with other modes as required, however, some combinations are not possible. If a prohibited combination is selected, a message will appear in the touch panel.



ROTATE COPY DOES NOT WORK



Check

Did you select the copy ratio manually?

Are you copying using settings that do not allow rotate copying?

Is "Rotation Copy Setting" disabled in the setting mode?



Solution

- Use automatic ratio selection when copying.

- Rotate copying can generally be combined with other modes as required, however, some combinations are not possible. If a prohibited combination is selected, a message will appear in the touch panel.

- Check with your administrator.
If you are the administrator, enable [Rotation Copy Setting].
⇒ Select [System Settings] → [Copy Settings] → [Condition Settings] → [Rotation Copy Setting] → [Rotation Copy] in "Settings".



ENLARGE/REDUCE DOES NOT WORK



Check

Are the original, paper, and ratio settings correct?



Solution

- Check if the original size that appears on the screen is correct. After that, check if the correct paper is selected. Tap the [Ratio] key and then tap the [Auto Image] key. The appropriate ratio for the original and paper will appear.



THE IMAGE IS TOO LIGHT OR TOO DARK



Check

Is the image too light?

Is the image too dark?

Has an appropriate exposure mode for the original type been selected?

Is the overall copy density too light?



Solution

■ Select an appropriate exposure mode for the original being copied and adjust the exposure level manually.

■ Select one of the following modes depending on the original type. (This can be set in normal mode.)

• **Text**

Use this mode for regular text documents.

• **Text/Printed Photo**

This mode provides the best balance for copying an original which contains both text and printed photographs, such as a magazine or catalogue.

• **Text/Photo**

This mode provides the best balance for copying an original which contains both text and photographs, such as a text document with a photo pasted on.

• **Printed Photo**

This mode is best for copying printed photographs, such as photos in a magazine or catalogue.

• **Photo**

Use this mode to copy photos.

• **Map**

This mode is best for copying the light color shading and fine text found on most maps.

• **Light Original**

Use this mode for originals with light pencil writing.

■ Change the overall copy density with either method below.

• **Changing the default setting**

Select "Settings (Web version)" - [System Settings] → [Image Quality Adjustment] → [Copy Image Quality] → [Quick Image Quality Adjustment]. Set default setting [2] to [3 (Sharp)] to increase the overall density, or [1 (Smooth)] to decrease the overall density.

• **Temporarily changing the setting**

Select Normal Mode (the setting cannot be changed in Easy Mode). In [Others] → [Quick Image Quality Adjustment], set default setting [2] to [3 (Sharp)] to increase the overall density, or [1 (Smooth)] to decrease the overall density. The setting is automatically reset when you return to the home screen.



PART OF THE IMAGE IS CUT OFF



Check

Has an appropriate ratio been selected for the original size and paper size?

Are you using an AB (inch) size original?



Solution

■ Select an appropriate ratio setting.

■ When copying an AB (inch) size original, specify the original size manually.



COPIES COME OUT BLANK



Check

Is the original placed face up or face down correctly?



Solution

■ When using the document glass, the original must be placed face down. When using the automatic document feeder, the original must be placed face up.



I WANT TO COPY MULTIPLE A4 PAGES ONTO ONE A4 SHEET OF PAPER



Check

Use N-Up.



Solution

■ N-Up lets you reduce and copy the images of up to eight A4 pages on one sheet. Tap the [N-Up] key. In normal mode, you can also add borders to N-Up copies.



CHECK LIST

Have functions been disabled by the administrator?

Some functions may have been disabled in the setting mode. When user authentication is enabled, the functions that you can use may be restricted in your user settings. Check with your administrator.

? Problem	✓ Check	Page
PRINTING DOES NOT TAKE PLACE	Is your PC connected correctly to the machine?	30
	Is the machine connected to the same network (LAN, etc.) as your PC?	30
	Is the IP address selected correctly? (Windows)	30
	Are you using a printer port created using Standard TCP/IP Port? (Windows)	30
	Is your computer in an unstable state?	30
	Is the machine specified correctly in the application that you are using for printing?	30
	Are the network connection devices operating normally?	30
	Is the I/O timeout setting too short?	31
	Was a Notice Page printed?	31
	Have functions been disabled by the administrator?	31
I DON'T KNOW WHICH PRINTER DRIVER TO INSTALL	Check the features of each printer driver before installing.	31
I DON'T KNOW HOW TO CANCEL PRINTING	Follow the steps below to cancel printing	32
I DON'T KNOW HOW TO PRINT ON SPECIAL MEDIA (POSTCARDS, ENVELOPES, ETC.)	Load postcards in tray 1 or the bypass tray. Load envelopes or other special media in the bypass tray.	32
2-SIDED PRINTING DOES NOT TAKE PLACE	Does the paper type setting of the selected tray specify a type of paper that cannot be used for 2-sided printing?	33
	Are you using a special size or type of paper?	33
	Have functions been disabled by the administrator?	33
DIRECT PRINTING OF A FILE IN A SHARED FOLDER ON A COMPUTER IS NOT POSSIBLE	Is [IPsec Settings] enabled on the machine?	33
A TRAY, FINISHER, OR OTHER PERIPHERAL DEVICE INSTALLED ON THE MACHINE CANNOT BE USED	Have the peripheral devices that are installed on the machine been configured with the printer driver?	33
THE IMAGE IS GRAINY	Are the printer driver settings appropriate for the print job?	34
THE IMAGE IS TOO LIGHT OR TOO DARK	Is the overall print density too light?	34
	Does the image (particularly a photo) need correction? (Windows)	34
TEXT AND LINES ARE FAINT AND DIFFICULT TO SEE	Was color data printed in black and white? (Windows)	35
	Is the overall print density too light?	35
	Are there fine lines in the original data?	35
PART OF THE IMAGE IS CUT OFF	Does the paper size specified by the job match the size of paper loaded into the tray?	35
	Is the print orientation setting (portrait or landscape) correct?	35
	Are the margins set correctly in the layout settings of the application?	35
THE IMAGE IS UPSIDE DOWN	Are you using a type of paper (envelopes, punch paper, etc.) that can only be loaded in a fixed orientation?	36
	Is the correct binding position selected for 2-sided printing?	36
MANY GARBLED CHARACTERS ARE PRINTED	Is your computer or the machine in an unstable state?	36



? Problem	✓ Check	Page
AFTER THE ROUTER WAS REPLACED, I CAN NO LONGER PRINT TO THE MACHINE	Does your computer connect to the machine?	37

? PRINTING DOES NOT TAKE PLACE

✓ Check	! Solution
Is your PC connected correctly to the machine?	<ul style="list-style-type: none"> ■ Make sure that the cable is connected securely to the LAN connector of your PC and that of the machine. If you are connecting to a network, make sure that the LAN cable is securely connected to the hub as well. ▶ Power and connector positions (page 4)
Is the machine connected to the same network (LAN, etc.) as your PC?	<ul style="list-style-type: none"> ■ The machine must be connected to the same network as your PC. If you do not know which network the machine is connected to, ask the network administrator.
Is the IP address selected correctly? (Windows)	<ul style="list-style-type: none"> ■ Check the IP address setting. If the machine does not have a permanent IP address (the machine receives an IP address from a DHCP server), printing will not be possible if the IP address changes. You can check the machine's IP address in [Network Status] of setting mode. If the IP address has changed, change the port setting in the printer driver. ⇒ "Settings" → [Status] → [Network Status] See: Software Setup Guide If the IP address changes frequently, it is recommended that a permanent IP address be assigned to the machine. ⇒ "Settings (administrator)" → [System Settings] → [Network Settings]
Are you using a printer port created using Standard TCP/IP Port? (Windows)	<ul style="list-style-type: none"> ■ Check the PC settings. When a port created with Standard TCP/IP Port in Windows is used and the [SNMP Status Enabled] checkbox is <input checked="" type="checkbox"/>, it may not be possible to print correctly. Change the [SNMP Status Enabled] checkbox to <input type="checkbox"/>. See: Software Setup Guide
Is your computer in an unstable state?	<ul style="list-style-type: none"> ■ Restart your computer. Printing is sometimes not possible when you run multiple applications at once or there is insufficient memory or hard drive space. Restart your computer.
Is the machine specified correctly in the application that you are using for printing?	<ul style="list-style-type: none"> ■ Check whether the machine's printer driver has been selected from the print window of the application. If the machine's printer driver does not appear in the list of available printer drivers, it may not be installed correctly. Remove the printer driver and then install it once again. See: Software Setup Guide
Are the network connection devices operating normally?	<ul style="list-style-type: none"> ■ Make sure that the routers and other network connection devices are operating correctly. If a device is not powered on or is in an error state, see the manual of the device to correct the problem.



Check

Is the I/O timeout setting too short?



Solution

- Check with your administrator.
If the I/O timeout setting is too short, errors may occur while writing to the printer. Ask the administrator of the machine to configure an appropriate time in "I/O Timeout".
⇒ "Settings (administrator)" → [System Settings] → [Printer Settings] → [Condition Settings] → [Interface Settings] → [I/O Timeout].

Was a Notice Page printed?

- Check the Notice Page.
A Notice Page will be printed to indicate the cause of the problem if a print job cannot be performed as specified and the cause is not shown in the display. Read the printed page and take appropriate actions.
For example, a Notice Page will be printed in the following situations.
 - The print job is too large to fit in memory.
 - A function that has been prohibited by the administrator is specified.
 By factory default, Notice Pages are not printed.

Have functions been disabled by the administrator?

- Check with your administrator.
When user authentication is enabled, the functions that you can use may be restricted in your user settings. Check with your administrator.



I DON'T KNOW WHICH PRINTER DRIVER TO INSTALL



Check

Check the features of each printer driver before installing.



Solution

- Each printer driver has specific features. Install and use the printer drivers that match your needs.
 - PCL6 printer driver
The machine supports the Hewlett-Packard PCL6 printer control languages. Prints fast and is good for regular print jobs.
 - PS printer driver (On the MX-M2630/M3050/M3550/M4050/M5050/M6050, the PS3 expansion kit is required.)
The PS printer driver supports the PostScript 3 page description language developed by Adobe Systems Incorporated. Excellent reproduction of images that include fine graphics.
 - PPD driver (On the MX-M2630/M3050/M3550/M4050/M5050/M6050, the PS3 expansion kit is required.)
The PPD driver enables the machine to use the standard Windows PS printer driver.



I DON'T KNOW HOW TO CANCEL PRINTING



Check

Follow the steps below to cancel printing



Solution

- If the print data has not been spooled to the machine, refer to the manual for your operating system or application.
If the print data has been spooled to the machine, tap the [Job Status] key, the [Spool] key, or the [Job Queue] key, and select the job you want to delete from the list. Open the action panel and tap [Stop/Delete]. A message will appear to confirm the cancelation. Tap the [Cancel] key.



I DON'T KNOW HOW TO PRINT ON SPECIAL MEDIA (POSTCARDS, ENVELOPES, ETC.)



Check

Load postcards in tray 1 or the bypass tray. Load envelopes or other special media in the bypass tray.



Solution

- Load postcards in tray 1 or the bypass tray. Load special media such as envelopes in the bypass tray. After loading the media, set the paper size and paper in [Tray Settings] in the home screen. For more information on paper settings, see the "User's Manual" . When you have completed the settings on the machine, set the "Original Size" and "Paper Size" appropriately on the [Main] tab of the printer driver.



2-SIDED PRINTING DOES NOT TAKE PLACE



Check

Does the paper type setting of the selected tray specify a type of paper that cannot be used for 2-sided printing?

Are you using a special size or type of paper?

Have functions been disabled by the administrator?



Solution

- Check "Paper Tray Settings" in the setting mode.
⇒ "Settings" → [System Settings] → [Common Settings] → [Paper Settings] → [Paper Tray Settings] → [Tray Registration] → [Feeding Approved Job]
Check the [Tray Settings] in the home screen.
Tap the selected tray, and in the screen that appears, tap the [Paper Property] key.
If the [Disable Duplex] checkbox in the paper properties screen is , the tray cannot be used for duplex printing. Change the paper type to a type that can be used for duplex printing.

- For the paper types and sizes that can be used for two-sided copying, read "SPECIFICATIONS" in Start Guide.

- Check with your administrator.
Some functions may have been disabled in the setting mode. Check with your administrator.
When user authentication is enabled, the functions that you can use may be restricted in your user settings. Check with your administrator.



DIRECT PRINTING OF A FILE IN A SHARED FOLDER ON A COMPUTER IS NOT POSSIBLE



Check

Is [IPsec Settings] enabled on the machine?



Solution

- Check with your administrator.
When [IPsec Settings] is enabled in the setting mode, direct printing of a file in a shared folder may not be possible in your PC environment. For information about [IPsec Settings], consult your administrator.
⇒ "Settings" → [Security Settings] → [IPsec Settings]



A TRAY, FINISHER, OR OTHER PERIPHERAL DEVICE INSTALLED ON THE MACHINE CANNOT BE USED



Check

Have the peripheral devices that are installed on the machine been configured with the printer driver?



Solution

- Open the printer properties dialog box and click [Auto Configuration] on the [Options] tab. (Windows)
If auto configuration cannot be executed, see the Software Setup Guide.



THE IMAGE IS GRAINY



Check

Are the printer driver settings appropriate for the print job?



Solution

- Check the settings of the printer driver.
When selecting print settings, select a print mode from [600dpi], [600dpi (High Quality)], or [1200dpi]. When you need a very clear image, select [1200dpi].
Windows: The resolution setting is selected in the [Image Quality] tab of the printer driver properties window.
Mac OS: Select [Advanced2] menu on the [Printer Features] in the print window.



THE IMAGE IS TOO LIGHT OR TOO DARK



Check

Is the overall print density too light?



Solution

Does the image (particularly a photo) need correction?
(Windows)

- Use the setting below to change the overall print density.
Select "Settings (Web version)" - [System Settings] → [Image Quality Adjustment] → [Print Image Quality] → [Quick Image Quality Adjustment]. Set default setting [2] to [3 (Sharp)] to increase the overall density, or [1 (Smooth)] to decrease the overall density.
- Check the settings of the printer driver.
Correct brightness and contrast with [Image Quality] on the [Color Adjustment] tab of the printer driver. Use these settings to make simple corrections in a case such as when image editing software is not installed on your computer.



TEXT AND LINES ARE FAINT AND DIFFICULT TO SEE



Check

Was color data printed in black and white?
(Windows)

Is the overall print density too light?

Are there fine lines in the original data?



Solution

■ Check the settings of the printer driver.
When color text and lines are printed in black and white, they may become faint and difficult to see. To have color text or lines (areas) that could become faint converted to black, select [Text To Black] or [Vector To Black] on the [Image Quality] tab of the printer driver. (Raster data such as bitmap images cannot be adjusted.)

■ Use the setting below to change the overall print density.
Select "Settings (Web version)" - [System Settings] → [Image Quality Adjustment] → [Print Image Quality] → [Quick Image Quality Adjustment]. Set default setting [2] to [3 (Sharp)] to increase the overall density, or [1 (Smooth)] to decrease the overall density.

■ Change the width of specific printed lines.
Select "Settings (Web version)" - [System Settings] → [Image Quality Adjustment] → [Print Image Quality] → [Line Thickness]. Increase the value of default setting [5] to make the lines thicker, or decrease the value to make the lines thinner. (Text and raster data such as bitmap images cannot be changed.)



PART OF THE IMAGE IS CUT OFF



Check

Does the paper size specified by the job match the size of paper loaded into the tray?

Is the print orientation setting (portrait or landscape) correct?

Are the margins set correctly in the layout settings of the application?



Solution

■ Make sure that the paper size setting matches the size of paper loaded into the tray.
Windows: The setting is selected in the [Paper Source] tab of the printer driver. If [Paper Tray] is selected, check the loaded paper and the paper size setting.
Mac OS: The setting is selected in the [Page Setup] menu.

■ Set the print orientation to match the image.
Windows: The setting is selected in the [Main] tab of the printer driver.
Mac OS: The setting is selected in the [Page Setup] menu.

■ Select an appropriate paper size and margins in the layout settings of the application.
If the edge of the image extends outside the printable area of the machine, the edge will be cut off.



THE IMAGE IS UPSIDE DOWN



Check

Are you using a type of paper (envelopes, punch paper, etc.) that can only be loaded in a fixed orientation?

Is the correct binding position selected for 2-sided printing?



Solution

- Rotate the image 180 degrees before printing.
When the image size and paper size are the same but the orientations are different, the orientation of the image is automatically rotated to match the paper. However, when the paper can only be loaded in a fixed orientation, the image may be printed upside down. In this event, rotate the image 180 degrees before printing.
Windows: The setting is selected in "Orientation" on the [Main] tab of the printer driver.
Mac OS: The setting is selected in the [Layout] menu of the print window.
- Be sure to set the appropriate binding position.
When 2-sided printing is performed, every other page is printed upside down when tablet binding is selected for the binding position.
Windows: The setting is selected in the [Main] tab of the printer driver.
Mac OS: The setting is selected in the [Layout] menu of the print window.



MANY GARBLED CHARACTERS ARE PRINTED



Check

Is your computer or the machine in an unstable state?



Solution

- Cancel printing, restart your PC and the machine, and try printing again.
If there is only a small amount of free space remaining in the memory or hard drive of your PC, or if a large number of jobs have been spooled on the machine and only a small amount of free space remains, text may be printed as garbled characters.
To cancel printing:
 - Windows:
Double-click the printer icon that appears at the lower right of the task bar and click "Cancel All Documents" (or "Purge Print Documents") in the [Printer] menu.
 - Mac OS:
Double-click the name of the machine in the printer list, select the job that you wish to delete, and delete it.
 - At the machine:
Tap the job status display on the operation panel, tap the [Print] tab to change the screen, tap the key of the print job that you wish to delete, and tap the [Stop/Delete] key. A message will appear to confirm the cancelation. Tap the [Cancel] key.
If some printed characters are still garbled after restarting, ask your administrator to lengthen the timeout setting of [I/O Timeout] in the setting mode.
⇒ "Settings (administrator)" → [System Settings] → [Printer Settings] → [Condition Settings] → [I/O Timeout].
If garbled characters are being still printed after the above measures are taken, remove and then reinstall the printer driver.



AFTER THE ROUTER WAS REPLACED, I CAN NO LONGER PRINT TO THE MACHINE



Check

Does your computer connect to the machine?



Solution

- The network connection between the machine and your computer may not be working correctly. Check the machine's IP address and your computer's IP address, and make sure that your computer can connect to the machine. Also check if the correct "Print Port" is specified in your computer's driver settings.
 - Check the IP address setting.

If the machine does not have a permanent IP address (the machine receives an IP address from a DHCP server), printing will not be possible if the IP address changes. You can check the machine's IP address in [Network Status] of setting mode. If the IP address has changed, change the port setting in the printer driver.
⇒"Settings" → [Status] → [Network Status]
See: Software Setup Guide

If the IP address changes frequently, it is recommended that a permanent IP address be assigned to the machine.
⇒"Settings (administrator)" → [System Settings] → [Network Settings]
 - Check if the correct print port is set on the computer.

Windows:
Click the [Start] button, select [Settings] → [Device] → [Devices and Printers]. (In Windows 8.1/Windows Server 2012, right-click the [Start] button, select [Control Panel] → [View devices and printers] (or [Devices and Printers]).) (In Windows 7/Windows Server 2008, click the [Start] button, select [Devices and Printers].)
Select and then right-click the printer → [Printer properties]→ [Port]

Mac OS:
Delete and then reinstall the printer.



CHECKLIST

Have functions been disabled by the administrator?

Some functions may have been disabled in the setting mode. When user authentication is enabled, the functions that you can use may be restricted in your user settings. Check with your administrator.

Problem	Check	Page
TRANSMISSION DOES NOT TAKE PLACE	Is the telephone line connected securely?	39
	Is the correct dial mode set for your line?	39
	Is a busy signal received?	39
	Did a communication error occur?	39
	Does a message appear indicating that the memory is full?	39
	Does a message appear notifying you that the original size was not detected?	40
	Does the job status screen (completed jobs) or a transaction report indicate that the transmission was not successful?	40
	Did you place an original that is folded?	40
	Are the sub-address and passcode correct? (When using F-code communication)	40
THE TRANSMITTED FAX PRINTS OUT BLANK AT THE RECEIVING SIDE	Is the original placed face up or face down correctly?	40
	If the receiving machine is using thermal paper, was the thermal paper loaded with the wrong side out?	40
THE TRANSMITTED FAX IS REDUCED BY THE RECEIVING FAX MACHINE	Has the rotation sending been set?	40
TRANSMISSION DOES NOT BEGIN AT THE SPECIFIED TIME	Is the machine's clock set to the correct time?	41
	Is a transmission in progress?	41
PRINTING DOES NOT TAKE PLACE AFTER RECEPTION	Does a password entry screen appear?	41
	Has cut-off printing been disabled in the setting mode (administrator)?	41
	Is forwarding (Inbound Routing function) enabled for a received fax?	41
MANUAL RECEPTION/POLLING RECEPTION ARE NOT POSSIBLE	Is little free memory remaining?	42
THE RECEIVED IMAGE IS FAINT	Is the original that was faxed also faint?	42
THE MACHINE DOES NOT BEGIN FAX RECEPTION	Has the reception mode been set to [Manual Reception] in the setting mode?	42
	Is little free memory remaining?	42
DIALING IS NOT POSSIBLE	Is the extension telephone connected?	43
	Is the external telephone enabled in setting mode? (When an external telephone is connected)	43
	Is the line busy?	43
YOU CANNOT TALK TO THE OTHER PARTY	Did you dial using the speaker?	43
AN ADDRESS (A ONE-TOUCH INDIVIDUAL KEY OR GROUP KEY) CANNOT BE STORED	Has the maximum number of keys been stored?	44
AN ADDRESS (A ONE-TOUCH INDIVIDUAL KEY OR GROUP KEY) CANNOT BE EDITED OR DELETED	Is the key being used in a reserved transmission or a transmission in progress?	44
	Have functions been disabled by the administrator?	44
	Has your administrator enabled a function that prevents editing/deleting?	44
I WANT TO CHECK THE SEND/RECEIVE HISTORY	Press the [Sending History] key. (Send history only)	44
	Check with the [Job Status] key.	44
I DON'T KNOW HOW TO FORWARD RECEIVED FAXES	Use the received fax forwarding settings in setting mode.	45



Problem	Check	Page
I DON'T KNOW HOW TO PREVIEW RECEIVED FAXES	Enable the image preview setting for received faxes in setting mode.	45
NOTIFICATION SOUNDS ARE TOO LOUD OR TOO SOFT, OR ARE NOT AUDIBLE (VOLUME ADJUSTMENT)	Have you adjusted the volume in the speaker settings of setting mode?	46
	You can adjust the volume of the original scan complete sound in the scan complete sound setting of setting mode.	46
I DON'T KNOW HOW TO STORE OR PRINT SENDER INFORMATION	You can store sender information in "Own Name and Destination Set" in setting mode.	46
BROADCAST TRANSMISSION DOES NOT WORK	Has broadcast setting been disabled in the setting mode (administrator)?	46
THE DATA NOTIFICATION INDICATOR DOES NOT TURN OFF	Did you retrieve a received fax that was printed?	47
	Is an error preventing received faxes from being printed?	47
I DON'T KNOW HOW TO CHECK AN ADDRESS WHEN SENDING A FAX	Tap the [Address Review] key.	47
	Is "Fax Dest. Confirmation Mode" enabled in setting mode?	47

TRANSMISSION DOES NOT TAKE PLACE

Check	Solution
Is the telephone line connected securely?	<ul style="list-style-type: none"> Check the telephone line jack, the wall jack, and any extension adapters to make sure that all connections are secure. <ul style="list-style-type: none"> ▶ Power and connector positions (page 4)
Is the correct dial mode set for your line?	<ul style="list-style-type: none"> Ask your administrator to verify that "Dial Mode Setting" is set correctly for the line you are using. <p>Select the telephone line type in "Dial Mode Setting" in the setting mode (administrator).</p> <p>⇒ "Settings" → [System Settings] → [Image Send Settings] → [Fax Settings] → [Default Settings] → [Dial Mode Setting]</p>
Is a busy signal received?	<ul style="list-style-type: none"> If a busy signal is received, the transmission is temporarily canceled and then automatically attempted again after a brief interval. The factory default setting : Two attempts at 3-minute intervals. <p>⇒ "Settings" → [System Settings] → [Image Send Settings] → [Fax Settings] → [Send Setting] → [Recall in Case of Line Busy]</p> <p>To cancel transmission, tap the job status display on the operation panel, tap the key of the job you want to delete, and tap [Stop/Delete] on the action panel. A message will appear to confirm the cancelation. Tap the [Cancel] key.</p>
Did a communication error occur?	<ul style="list-style-type: none"> If an error occurs preventing transmission, the transmission is temporarily canceled and then automatically re-attempted after a brief interval. The factory default setting : Two attempts at 3-minute intervals. <p>⇒ "Settings (administrator)" → [System Settings] → [Image Send Settings] → [Fax Settings] → [Send Setting] → [Recall in Case of Communication Error]</p> <p>To cancel transmission, tap the job status display on the operation panel, tap the key of the job you want to delete, and tap [Stop/Delete] on the action panel. A message will appear to confirm the cancelation. Tap the [Cancel] key.</p> <p>The machine supports error correction mode (ECM) and is configured to automatically resend any part of a fax that is distorted due to noise on the line.</p> <p>⇒ "Settings" → [System Settings] → [Image Send Settings] → [Fax Settings] → [Default Settings] → [ECM]</p>
Does a message appear indicating that the memory is full?	<ul style="list-style-type: none"> Divide the originals into sets and fax each set separately, or use direct transmission. If the memory becomes full, the transmission will be canceled.



Check



Solution

Does a message appear notifying you that the original size was not detected?

- Place the original again.
If the original size is still not detected correctly, specify the original size manually.

Does the job status screen (completed jobs) or a transaction report indicate that the transmission was not successful?

- Perform the transmission again.
If the transmission is still not successful after recalling is performed as set in [Recall in Case of Line Busy] or [Recall in Case of Communication Error], the transmission failure will be indicated in the job status screen and the transaction report.

Did you place an original that is folded?

- Following the instructions in the display, unfold the original, place it in the automatic document feeder again, and re-scan it.
If a folded original is placed in the automatic document feeder, an error will occur and scanning will be canceled when the actual original size is detected during scanning.

Are the sub-address and passcode correct? (When using F-code communication)

- Check with the operator of the other machine to make sure that the sub-address and passcode are correct.



THE TRANSMITTED FAX PRINTS OUT BLANK AT THE RECEIVING SIDE



Check



Solution

Is the original placed face up or face down correctly?

- Place the original again in the correct orientation, and resend.
When using the document glass, the original must be placed face down. When using the automatic document feeder, the original must be placed face up. Place the original correctly and send the fax again.

If the receiving machine is using thermal paper, was the thermal paper loaded with the wrong side out?

- Check with the operator of the other machine.



THE TRANSMITTED FAX IS REDUCED BY THE RECEIVING FAX MACHINE



Check



Solution

Has the rotation sending been set?

- Enable "Rotation Sending Setting" before transmission.
When [Rotation Sending Setting] is not enabled (the image is not rotated), an original placed in the vertical orientation may be reduced by the receiving machine.
⇒ "Settings" → [System Settings] → [Image Send Settings] → [Fax Settings] → [Send Setting] → [Rotation Sending Setting] →
If "Mixed Size Original" is enabled in Others and an original with a different width is sent, rotate transmission will be disabled.



TRANSMISSION DOES NOT BEGIN AT THE SPECIFIED TIME



Check

Is the machine's clock set to the correct time?

Is a transmission in progress?



Solution

■ Set the clock to the correct time.
⇒ "Settings" → [System Settings] → [Common Settings] → [Clock]

■ If another transmission is in progress when the specified time arrives, the timer operation will begin after that transmission is finished.



PRINTING DOES NOT TAKE PLACE AFTER RECEPTION



Check

Does a password entry screen appear?

Has cut-off printing been disabled in the setting mode (administrator)?

Is forwarding (Inbound Routing function) enabled for a received fax?



Solution

■ Enter the correct password using the numeric keys.
[Hold Setting for Received Data Print] is enabled. If you do not know the password, check with your administrator.
⇒ "Settings (administrator)" → [System Settings] → [Image Send Settings] → [Common Settings] → [Condition Settings] → [Hold Setting for Received Data Print]

■ Load the same size of paper as the received fax.
If [Print Actual Size Cut off Disabled] is enabled in [Print Style Setting] in the setting mode (administrator) and a fax is received that is larger than any paper that is loaded, the fax will be received and stored in memory without being printed. (However, when a fax longer than A3 (11" x 17") size is received, it will be printed using multiple sheets of paper.)
⇒ "Settings" → [System Settings] → [Image Send Settings] → [Fax Settings] → [Receive Settings] → [Print Style Setting]

■ If you need to print a received fax, ask your administrator.
When the Inbound Routing function is enabled, received faxes are automatically forwarded to a specified address. If [Print at Error] is selected when Inbound Routing is enabled, received faxes will only be printed when an error occurs.
⇒ "Settings (administrator)" → [Image Send Settings] → [Inbound Routing (Forwarding/Storing) Settings] → [Administration Settings] → [Inbound Routing Settings]



MANUAL RECEPTION/POLLING RECEPTION ARE NOT POSSIBLE



Check

Is little free memory remaining?



Solution

- If any of the following applies, print or delete received faxes to increase available memory space for receiving faxes.
 - The memory contains data that has been received with the received image check setting enabled.
 - The memory contains data that has been received with confidential reception or that is protected by a password.
 - A fax is stored in the memory box.



THE RECEIVED IMAGE IS FAINT



Check

Is the original that was faxed also faint?



Solution

- Ask the other party to send the fax again using a suitable (darker) exposure setting.



THE MACHINE DOES NOT BEGIN FAX RECEPTION



Check

Has the reception mode been set to [Manual Reception] in the setting mode?



Solution

- Set the reception mode to [Auto Reception].
When the reception mode is set to [Manual Reception], the machine will not receive faxes automatically.
⇒ "Settings (administrator)" → [System Settings] → [Image Send Settings] → [Fax Data Receive/Forward (Manual)] → [Fax Settings] → [Receive Settings]
When [Switching from Manual to Automatic Reception] is selected in setting mode and a fax is received in manual reception mode, the machine will automatically switch to automatic reception after the specified number of rings and receive the fax.
Ask your administrator to enable this setting.
⇒ "Settings (administrator)" → [System Settings] → [Image Send Settings] → [Fax Settings] → [Receive Settings] → [Switching from Manual to Automatic Reception] → [Switching to Automatic Reception] →

Is little free memory remaining?

- Increase the amount of free memory.
 - The memory contains data that has been received with the received image check setting enabled.
 - The memory contains data that has been received with confidential reception or that is protected by a password.
 - A fax is stored in the memory box.



DIALING IS NOT POSSIBLE



Check

Is the extension telephone connected?

Is the external telephone enabled in setting mode?
(When an external telephone is connected)

Is the line busy?



Solution

- Check the connections.
Check the telephone line jack, the wall jack, and any extension adapters to make sure that all connections are secure.
- Ask your administrator to enable [External Telephone Setting]/
⇒ "Settings (administrator)" → [System Settings] → [Image Send Settings] → [Fax Settings] → [Default Settings] → [External Telephone Setting] →
- Wait until the communication is completed.



YOU CANNOT TALK TO THE OTHER PARTY



Check

Did you dial using the speaker?



Solution

- Use the extension telephone.
When you dial using the speaker, you will be able to hear the voice of the other party, but he or she will not hear your voice. Use the extension telephone. (When the extension telephone is not installed, you cannot talk to the other party.)



AN ADDRESS (A ONE-TOUCH INDIVIDUAL KEY OR GROUP KEY) CANNOT BE STORED



Check

Has the maximum number of keys been stored?



Solution

- Adjust the number of stored keys.
Delete addresses (one-touch keys and group keys) that are not being used.



AN ADDRESS (A ONE-TOUCH INDIVIDUAL KEY OR GROUP KEY) CANNOT BE EDITED OR DELETED



Check

Is the key being used in a reserved transmission or a transmission in progress?

Have functions been disabled by the administrator?

Has your administrator enabled a function that prevents editing/deleting?



Solution

- Wait until the transmission is finished or cancel the reserved transmission and then edit or delete the key.
- Check with your administrator.
Some functions may have been disabled in the setting mode.
- Check with your administrator.
If your administrator has enabled settings such as [Inbound Routing Settings], keys cannot be edited or removed.
⇒ "Settings (administrator)" → [Image Send Settings]
→ [Inbound Routing (Forwarding/Storing) Settings] → [Inbound Routing Settings]



I WANT TO CHECK THE SEND/RECEIVE HISTORY



Check

Press the [Sending History] key. (Send history only)

Check with the [Job Status] key.



Solution

- Tap the [Sending History] key (Easy Fax mode) to show the send history. In normal mode, tap the [Sending History] key on the action panel.
- Tap the [Job Status] key and tap the [Fax] tab to check the status of fax jobs. To check previous send or receive histories, tap the [Complete] key. To print communication results, open the action panel and tap [Print Image Sending Activity Report].



I DON'T KNOW HOW TO FORWARD RECEIVED FAXES



Check

Use the received fax forwarding settings in setting mode.



Solution

- You can forward received faxes to a forwarding destination set in advance. Enable [Inbound Routing Settings] in "Settings (administrator)" - [System Settings] → [Image Send Settings] → [Inbound Routing (Forwarding/Storing) Settings]. Tap [Add] and set the forwarding destination and forwarding conditions. When the settings are completed, received faxes will be forwarded according to the set conditions.



I DON'T KNOW HOW TO PREVIEW RECEIVED FAXES



Check

Enable the image preview setting for received faxes in setting mode.



Solution

- You can forward received faxes to a forwarding destination set in advance. Enable [Received Data Image Check Setting] in "Settings (administrator)" - [System Settings] → [Image Send Settings] → [Common Settings] → [Condition Settings] → [Preview Setting]. When a fax is received, tap the icon that appears next to the [Job Status] key at the top of the screen. In the system information screen that appears, tap the [Event Information] tab and tap the [Check Fax Reception Image] key. Tap the key of the received fax that you want to check, and tap [Check Image] on the action panel to show a preview of the fax.



NOTIFICATION SOUNDS ARE TOO LOUD OR TOO SOFT, OR ARE NOT AUDIBLE (VOLUME ADJUSTMENT)



Check

Have you adjusted the volume in the speaker settings of setting mode?

You can adjust the volume of the original scan complete sound in the scan complete sound setting of setting mode.



Solution

■ Adjust the on-hook volume, ringing volume, line monitor volume, send/receive completion volume, and send/receive error volume in "Settings (administrator)".
⇒ "Settings (administrator)" → [System Settings] → [Image Send Settings] → [Fax Settings] → [Default Settings] → [Speaker Settings]

■ A complete sound is heard when scanning of the original is completed. In "Settings (administrator)", select [System Settings] → [Image Send Settings] → [Common Settings] → [Condition Settings] → [Scan Complete Sound Setting] to adjust the volume.



I DON'T KNOW HOW TO STORE OR PRINT SENDER INFORMATION



Check

You can store sender information in "Own Name and Destination Set" in setting mode.



Solution

■ To store sender information, select "Settings (administrator)" - [System Settings] → [Image Send Settings] → [Common Settings] → [Own Name and Destination Set].



BROADCAST TRANSMISSION DOES NOT WORK



Check

Has broadcast setting been disabled in the setting mode (administrator)?



Solution

■ Broadcast transmission cannot be performed when "Settings (administrator)" - [System Settings] → [Image Send Settings] → [Fax Settings] → [Send Setting] → [Disable Fax Broadcasting] is disabled.



THE DATA NOTIFICATION INDICATOR DOES NOT TURN OFF



Check

Did you retrieve a received fax that was printed?

Is an error preventing received faxes from being printed?



Solution

■ The data notification indicator blinks until received faxes are retrieved.

■ The data notification indicator blinks when a received fax remains in memory without being printed. Clear the error that is preventing printing.

I DON'T KNOW HOW TO CHECK AN ADDRESS WHEN SENDING A FAX



Check

Tap the [Address Review] key.

Is "Fax Dest. Confirmation Mode" enabled in setting mode?



Solution

■ Tap the [Address Review] key to view a list of the addresses.

■ Enable "Settings (administrator)" - [System Settings] → [Image Send Settings] → [Fax Settings] → [Default Settings] → [Fax Dest. Confirmation Mode]. When this setting is enabled, an address confirmation message will appear when you send a fax to prevent erroneous transmission.



CHECKLIST

Have functions been disabled by the administrator?

Some functions may have been disabled in the setting mode. When user authentication is enabled, the functions that you can use may be restricted in your user settings. Check with your administrator.

Problem	Check	Page
TRANSMISSION DOES NOT TAKE PLACE	Did you select the correct destination (destination information)? Is the correct information (e-mail address or FTP server information) stored for that destination?	49
	Does the image file exceed the e-mail attachment limit set in the setting mode (administrator)?	49
	Did the image file exceed the file attachment size limit of your mail server? (When Scan to E-mail is used)	49
	Has the folder on the destination computer been set as a shared folder so that files can be sent to it? (When using Scan to Network Folder)	49
	Is [IPsec Settings] enabled on the machine? (When using Scan to Network Folder)	49
	Did you place an original that is folded?	49
	Are both direct SMTP addresses and other addresses set as destinations?	49
AUTO SELECTION OF THE COLOR MODE DOES NOT TAKE PLACE CORRECTLY	Are you scanning one of the following types of originals?	50
THE RECEIVED IMAGE FILE CANNOT BE OPENED	Does the viewer program used by the recipient support the format of the received image data?	50
	Does a message appear prompting you to enter your password?	50
I DON'T KNOW HOW TO SPECIFY THE ORIGINAL/SEND SIZE	Are you using Easy mode?	50
TRANSMISSION TAKES A LONG TIME	Is the resolution setting appropriate at the time of scanning?	51
A DESTINATION IS PRE-SELECTED	Is [Default Address Setting] enabled in the setting mode?	51
THE SCANNED IMAGE IS CLIPPED	Is the original scan size setting smaller than the actual original size?	51
THE QUALITY OF THE SCANNED IMAGE IS POOR	Is the original printed matter such as a book or magazine?	52
	When scanning a color or grayscale original, is the color mode set to [Mono2]?	52
	Are Internet fax addresses included in the transmission?	52
	Is the resolution setting too low?	52
	Is the compression ratio too high?	52
THE SCANNED IMAGE IS BLANK	Is the original placed face up or face down correctly?	52
THE SCANNED IMAGE IS UPSIDE DOWN OR ON ITS SIDE	Are Internet fax addresses included in the transmission?	53
JPEG WAS SELECTED FOR THE FILE TYPE BUT THE FILE WAS CREATED AS A TIFF FILE	Did you select [Mono2] in color mode?	53
THE FILE SIZE IS LARGE	Was the color mode set to [Grayscale] when you scanned a monochrome original?	53
	Is the resolution setting too high?	53
	Is the compression ratio too low?	53
AN ADDRESS (A ONE-TOUCH INDIVIDUAL KEY OR GROUP KEY) CANNOT BE STORED	Has the maximum number of keys been stored?	54
AN ADDRESS (A ONE-TOUCH INDIVIDUAL KEY OR GROUP KEY) CANNOT BE EDITED OR DELETED	Is the key being used in a reserved transmission or a transmission in progress?	54
	Has your administrator enabled a function that prevents editing/deleting?	54



Problem	Check	Page
I WANT TO CHANGE THE FORMAT OR COMPRESSION OF A SCANNED IMAGE	Use the [Format] key.	54
I DON'T KNOW HOW TO CHECK AN ADDRESS WHEN SENDING AN IMAGE	Tap the [Address Review] key.	54
AFTER THE ROUTER WAS REPLACED, I CAN'T USE SCAN TO NETWORK FOLDER OR SCAN	Has the machine's IP address been changed?	55

TRANSMISSION DOES NOT TAKE PLACE

Check	Solution
Did you select the correct destination (destination information)? Is the correct information (e-mail address or FTP server information) stored for that destination?	<ul style="list-style-type: none"> Make sure that the correct information is stored for the destination and that the destination is correctly selected. If delivery by e-mail (Scan to E-mail) is unsuccessful, an error message such as "Undelivered Message" may be sent to the designated administrator's e-mail address. This information may help you determine the cause of the problem.
Does the image file exceed the e-mail attachment limit set in the setting mode (administrator)?	<ul style="list-style-type: none"> Check with your administrator. If your administrator has set a limit on the size of transmitted files, a file that exceeds the limit cannot be transmitted.
Did the image file exceed the file attachment size limit of your mail server? (When Scan to E-mail is used)	<ul style="list-style-type: none"> Reduce the size of the file attachment (reduce the number of pages to scan) for one e-mail transmission. The size of the file can also be reduced by scanning using a lower resolution setting. Ask your mail server administrator (or Internet service provider, etc.) what the file size limit is for one e-mail transmission. When [Send Destination Link] is selected, the data is saved to the machine's hard disk, and a URL link to the saved data is sent by e-mail to the destination. The recipient uses the link to download the file. Because this method is not affected by mail server restrictions, you can use it in instances such as when you cannot reduce the size of the file.
Has the folder on the destination computer been set as a shared folder so that files can be sent to it? (When using Scan to Network Folder)	<ul style="list-style-type: none"> If the destination folder is not configured as a shared folder, select "Sharing" in the folder properties. If the folder was moved or otherwise changed, the "Sharing" setting may have been canceled.
Is [IPsec Settings] enabled on the machine? (When using Scan to Network Folder)	<ul style="list-style-type: none"> Check with your administrator. When [IPsec Settings] is enabled in setting mode, it may not be possible to scan to a shared folder in some computer environments. ⇒ "Settings (administrator)" → [System Settings] → [Security Settings] → [IPsec Settings]
Did you place an original that is folded?	<ul style="list-style-type: none"> Following the instructions in the display, unfold the original, place it in the automatic document feeder again, and re-scan it. If a folded original is placed in the automatic document feeder, an error will occur and scanning will be canceled when the actual original size is detected during scanning.
Are both direct SMTP addresses and other addresses set as destinations?	<ul style="list-style-type: none"> Broadcast transmission to both direct SMTP addresses and other addresses is not possible. Send to direct SMTP addresses and other addresses separately.



? AUTO SELECTION OF THE COLOR MODE DOES NOT TAKE PLACE CORRECTLY

✓ Check

Are you scanning one of the following types of originals?

When Black & White is not selected:

- Are there colors or coloring in the paper?

When Color is not selected:

- Is the color in the original very light?
- Is the color in the original very dark, almost black?
- Is only a very small area of the original colored?

! Solution

- Specify the color mode manually.

When the color mode is set to [Auto], the machine detects whether the original is black and white or color when the [Color Start] key is tapped; however, in the cases as shown on the left, automatic detection may not give the correct result.

? THE RECEIVED IMAGE FILE CANNOT BE OPENED

✓ Check

Does the viewer program used by the recipient support the format of the received image data?

Does a message appear prompting you to enter your password?

! Solution

- Use a software program that is capable of opening the selected file type and compression mode.

The recipient may be able to open the file if you change the file type and compression mode selected at the time of transmission.

- Ask the sender for the password, or have the image sent again in a non-encrypted format.

The received file is an encrypted PDF file.

? I DON'T KNOW HOW TO SPECIFY THE ORIGINAL/SEND SIZE

✓ Check

Are you using Easy mode?

! Solution

- Use normal mode to set the original size and send size. Tap the [Original] key in the base screen of normal mode. Specify the scan size (original size), and specify the send size that will be received at the destination.



TRANSMISSION TAKES A LONG TIME



Check

Is the resolution setting appropriate at the time of scanning?



Solution

■ Select resolution and data compression settings that are suited to the purpose of transmission.

To create image data that is balanced in terms of resolution and file size, pay attention to the following points:

Resolution modes:

The default resolution setting is [200x200dpi] in "E-Mail", "FTP/Desktop", "Network Folder", and "Scan to External Memory Device", and [200x100dpi] in Internet fax mode. If the original does not contain a halftone image such as a photo or illustration, scanning at the default resolution will create a more practical and useful image. A higher resolution setting or the "Half Tone" setting (in Internet fax mode only) should only be selected if the original contains a photo and you wish to give priority to the quality of the photo image. Exercise caution in this case as a larger file will be created than when the default setting is used.



A DESTINATION IS PRE-SELECTED



Check

Is [Default Address Setting] enabled in the setting mode?



Solution

■ If you wish to send to a destination other than the default destination, tap the [Cancel] key.

If you are the administrator and wish to change or disable the default destination, change the settings as appropriate in [Default Address Setting].

⇒ "Settings (administrator)" → [System Settings] → [Image Send Settings] → [Scan Settings] → [Default Address] → [Default Address Setting]



THE SCANNED IMAGE IS CLIPPED



Check

Is the original scan size setting smaller than the actual original size?



Solution

■ Set the scan size to the actual original size.

If you have intentionally set a smaller size than the actual original size, place the original considering the reference placement position for the selected scan size. For example, when scanning an A4 (8-1/2" x 11") original using a B5 (5-1/2" x 8-1/2") setting on the document glass, align the original using the document glass scale at the left edge to fit the area you wish to scan into the B5 (5-1/2" x 8-1/2") scanning area.



? THE QUALITY OF THE SCANNED IMAGE IS POOR

✓ Check

Is the original printed matter such as a book or magazine?

When scanning a color or grayscale original, is the color mode set to [Mono2]?

Are Internet fax addresses included in the transmission?

Is the resolution setting too low?

Is the compression ratio too high?

! Solution

■ To reduce the moire effect, take the following procedure:
When the original is printed matter, vertical patterns (moire) may occur. Select [Others] → [Sharpness] in the Base Screen of normal mode and soften the edges of image to reduce the moire effect (only in "E-Mail", "FTP/Desktop", "Network Folder", and "Scan to External Memory Device"). It may also be possible to reduce the moire effect by changing the resolution setting or shifting the original (or changing its angle) slightly on the document glass.

■ Setting the color mode to [Mono2] replaces the colors in the original with either black or white. This is suitable for text-only originals; however, for originals that contain illustrations, it is best to use the [B/W Start] key with the color mode set to [Grayscale], or set the color mode of the [Color Start] key to [Full Color] or [Grayscale] and then scan.

■ If you wish to send an image scanned at high resolution to destinations for "E-Mail", "FTP/Desktop", and "Network Folder", send the image to scanner and Internet fax destinations separately.

■ A low resolution setting results in a coarser image. Increasing the resolution setting produces a smoother image. (The higher the resolution, the larger the file size.)

■ If the compression ratio is set to a high value when "Color Mode" transmission is set to full color or grayscale, noise may be noticeable and colors may appear dull. Set [File Format] → "Compression Ratio" to a lower value to reduce noise and dulling of color. (The lower the compression ratio, the larger the file size.) This is set in Normal Mode.

? THE SCANNED IMAGE IS BLANK

✓ Check

Is the original placed face up or face down correctly?

! Solution

■ Place the original again in the correct orientation, and resend.
When using the document glass, the original must be placed face down. When using the automatic document feeder, the original must be placed face up.



? THE SCANNED IMAGE IS UPSIDE DOWN OR ON ITS SIDE

✓ Check

Are Internet fax addresses included in the transmission?

! Solution

■ Send the image to the scan mode and Internet fax mode destinations separately. When destinations for "E-Mail", "FTP/Desktop", and "Network Folder" and Internet fax destinations are included in a broadcast transmission, the original transmission orientation of Internet fax takes precedence, and thus the file may not appear in the correct orientation when viewed on a PC.

? JPEG WAS SELECTED FOR THE FILE TYPE BUT THE FILE WAS CREATED AS A TIFF FILE

✓ Check

Did you select [Mono2] in color mode?

! Solution

■ Change the color mode to [Full Color] or [Grayscale], and then tap the [Start] key. When [JPEG] is selected for the file type and the image is scanned in Mono2, the file will be created as a TIFF file.

? THE FILE SIZE IS LARGE

✓ Check

Was the color mode set to [Grayscale] when you scanned a monochrome original?

! Solution

■ [Grayscale] is suitable when you want a high-quality image of text or a photo, but the file size will be larger. Using [Mono2] for a text-only original will significantly reduce the file size. This is set in Normal Mode.

Is the resolution setting too high?

■ The higher the resolution setting, the larger the file size. Lowering the resolution results in a coarser image, but produces a smaller file size.

Is the compression ratio too low?

■ If the compression ratio is set to a low value when Color Mode is set to [Full Color] or [Grayscale], the file size will be large. If [File Format] → [Compression Ratio] is set to a higher value, noise may become noticeable and colors may appear duller, but the file size will be smaller. This is set in Normal Mode.



AN ADDRESS (A ONE-TOUCH INDIVIDUAL KEY OR GROUP KEY) CANNOT BE STORED



Check

Has the maximum number of keys been stored?



Solution

- Adjust the number of stored keys.
Delete addresses (one-touch keys and group keys) that are not being used.



AN ADDRESS (A ONE-TOUCH INDIVIDUAL KEY OR GROUP KEY) CANNOT BE EDITED OR DELETED



Check

Is the key being used in a reserved transmission or a transmission in progress?



Solution

- Wait until the transmission is finished or cancel the reserved transmission and then edit or delete the key.

Has your administrator enabled a function that prevents editing/deleting?

- Check with your administrator.
If your administrator has enabled settings such as [Default Address Setting] and [Inbound Routing Settings], keys cannot be edited or removed.



I WANT TO CHANGE THE FORMAT OR COMPRESSION OF A SCANNED IMAGE



Check

Use the [Format] key.



Solution

- You can use the [Format] key to set the format and compression percentage of a file to be saved or sent. In normal mode, you can create a file of a number of original pages
[Specified Pages per File] can be used.



I DON'T KNOW HOW TO CHECK AN ADDRESS WHEN SENDING AN IMAGE



Check

Tap the [Address Review] key.



Solution

- Tap the [Address Review] key to view a list of the addresses.



AFTER THE ROUTER WAS REPLACED, I CAN'T USE SCAN TO NETWORK FOLDER OR SCAN



Check

Has the machine's IP address been changed?



Solution

■ Check the IP address setting.

If the machine does not have a permanent IP address (the machine receives an IP address from a DHCP server), scanning to network folder or scanning will not be possible if the IP address changes.

You can check the machine's IP address in [Network Status] of setting mode. If the IP address has changed, change the port setting in the printer driver.

⇒ "Settings" → [Status] → [Network Status]

See: Software Setup Guide

If the IP address changes frequently, it is recommended that a permanent IP address be assigned to the machine.

⇒ "Settings (administrator)" → [System Settings] → [Network Settings]



CHECK LIST

(Only the machine equipped with HDD)

Have functions been disabled by the administrator?

Some functions may have been disabled in the setting mode. When user authentication is enabled, the functions that you can use may be restricted in your user settings. Check with your administrator.

Problem	Check	Page
DOCUMENT FILING DOES NOT TAKE PLACE	Did you enable document filing in the printer driver?	56
A JOB CANNOT BE STORED IN A CUSTOM FOLDER	Do the custom folders created with the machine appear in "Folder Information"? (When printing)	57
	Does the custom folder have a PIN Code?	57
A STORED FILE HAS DISAPPEARED	Did you tap the [Print and Delete the Data] key to print a stored file?	57
	Has automatic deletion of document filing files been enabled?	57
A FILE CANNOT BE DELETED	Is the property of the file set to [Protect]?	57
THE PROPERTY OF A FILE CANNOT BE SET TO [Confidential]	Is the file in the Quick File folder?	58
A CONFIDENTIAL FILE OR CONFIDENTIAL FOLDER CANNOT BE OPENED	Did you enter the wrong password/PIN Code?	58
I CAN'T STORE OR CHANGE A FILE NAME OR CUSTOM FOLDER NAME	Does the name include characters that cannot be used in a file or folder name?	58
A FILE NAME IS CUT OFF	Was the file name stored in the advanced transmission settings during a scan or Internet fax transmission?	58
I DON'T KNOW HOW TO SCAN TO USB MEMORY	Did you insert the USB memory device?	59
	Did you select [Scan to USB] in [Scan to HDD/USB] of Easy Scan mode?	59
	Did you select [Scan to External Memory Device] in Document Filing mode?	59
I DON'T KNOW TO PRINT BY USB DIRECT PRINT	Did you insert the USB memory device?	59
	Did you select [Select File from USB Memory to Print] in Document Filing mode?	59



DOCUMENT FILING DOES NOT TAKE PLACE



Check



Solution

Did you enable document filing in the printer driver?

- Enable document filing.
In print mode, enable document filing on the [Job Handling] tab of the printer driver.
In other than print mode, specify Document Filing settings from Quick File or File.



A JOB CANNOT BE STORED IN A CUSTOM FOLDER

Check

Do the custom folders created with the machine appear in "Folder Information"?
(When printing)

Does the custom folder have a PIN Code?

Solution

■ Click the [Get Folder Name] button in the document filing save screen of the printer driver to call up the custom folders that have been created on the machine.

■ Enter the PIN Code configured in the machine in the document filing save screen.

A STORED FILE HAS DISAPPEARED

Check

Did you tap the [Print and Delete the Data] key to print a stored file?

Has automatic deletion of document filing files been enabled?

Solution

■ Tap the [Print and Save the Data] key to print again.
If you print the file by tapping the [Print and Delete the Data] key, the file is automatically deleted after being printed.
The file property can be set to [Protect] to prevent the file from being easily deleted.

■ If files that you need have been deleted, consult the administrator of the machine. When [Automatic Deletion of File Settings] is enabled in the setting mode, the files in the specified folders are periodically deleted. (Even when the file property is [Confidential] or [Protect], the file may be deleted.)
⇒ "Settings (administrator)" → [System Settings] → [Document Filing Settings] → [Automatic Deletion of File Settings]

A FILE CANNOT BE DELETED

Check

Is the property of the file set to [Protect]?

Solution

■ A file cannot be deleted when its property is set to [Protect].
Change the file property from [Protect] to [Sharing] and then delete the file.



THE PROPERTY OF A FILE CANNOT BE SET TO [Confidential]



Check

Is the file in the Quick File folder?



Solution

- Move the file to a different folder and then set its property to "Confidential". [Confidential] cannot be specified for a file in the Quick File folder. (Note that [Protect] can be specified for a file in the Quick File folder to prevent it from being easily deleted.)



A CONFIDENTIAL FILE OR CONFIDENTIAL FOLDER CANNOT BE OPENED



Check

Did you enter the wrong password/PIN Code?



Solution

- Check with your administrator.



I CAN'T STORE OR CHANGE A FILE NAME OR CUSTOM FOLDER NAME



Check

Does the name include characters that cannot be used in a file or folder name?



Solution

- The following characters cannot be used in a file or folder name:
? / " : < > * \ |



A FILE NAME IS CUT OFF



Check

Was the file name stored in the advanced transmission settings during a scan or Internet fax transmission?



Solution

- If the name was stored in the advanced transmission settings before Quick File or File settings were configured, that name will be used for the stored file. If the number of characters in the name exceeds the maximum number of characters allowed for a Quick File name (30 characters), characters after the 30th character will be discarded.



I DON'T KNOW HOW TO SCAN TO USB MEMORY



Check

Did you insert the USB memory device?

Did you select [Scan to USB] in [Scan to HDD/USB] of Easy Scan mode?

Did you select [Scan to External Memory Device] in Document Filing mode?



Solution

■ When you insert a USB memory device in the machine, a message will appear. To scan to USB memory, tap the [Scan to External Memory Device] key. The external memory device screen set in Easy Scan mode appears. Place the original and tap the [Start] key to scan the document into the USB memory device. You can select the [Perform Detail Setting] checkbox to select detailed save settings.

■ When [Scan to USB] is selected in [Scan to HDD/USB] of Easy Scan mode, the scanned document will be saved to the connected USB memory device.

■ When [Scan to External Memory Device] is selected on the action panel of Document Filing mode, the scanned document will be saved to the connected USB memory device.



I DON'T KNOW TO PRINT BY USB DIRECT PRINT



Check

Did you insert the USB memory device?

Did you select [Select File from USB Memory to Print] in Document Filing mode?



Solution

■ When you insert a USB memory device in the machine, a message will appear. To perform USB Direct Print, tap the [Print from external memory device (USB)] key.

■ Tap [Select File from USB Memory to Print] on the action panel of Document Filing mode.



Quick guide to frequently used printing methods

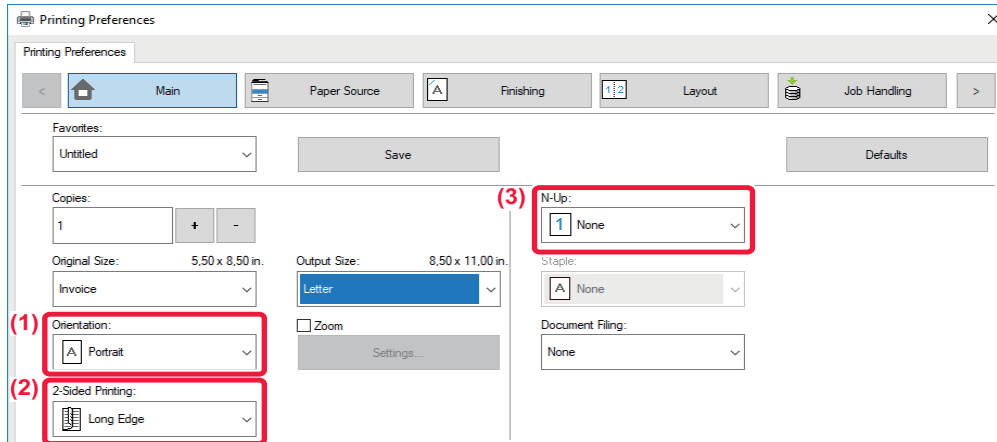

Output	Orientation of originals	Print result		Paper tray		Driver setting
				Tray type	Print side	
Duplex printing	 		➔	Trays 1 - 4	Face up	(1)
				<ul style="list-style-type: none"> • Bypass tray • Large capacity tray 	Face down	(2)*
Duplex printing	 		➔	Trays 1 - 4	Face up	(1)*
				<ul style="list-style-type: none"> • Bypass tray • Large capacity tray 	Face down	(2)*



Output	Orientation of originals	Print result	Paper tray		Driver setting
			Tray type	Print side	
Duplex printing and N-Up (2in1)			Trays 1 - 4	Face up	(1) (2)* (3)*
			<ul style="list-style-type: none"> • Bypass tray • Large capacity tray 	Face down	
			Trays 1 - 4	Face up	(1)* (2)* (3)*
			<ul style="list-style-type: none"> • Bypass tray • Large capacity tray 	Face down	

* Must be changed from default setting.

Booklet

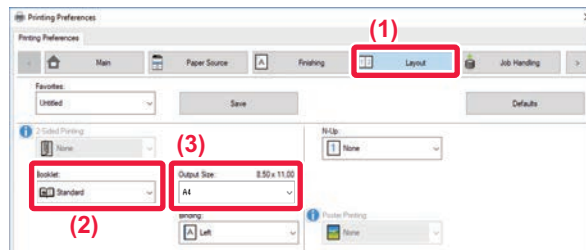
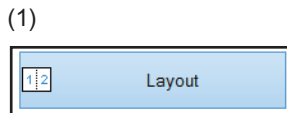
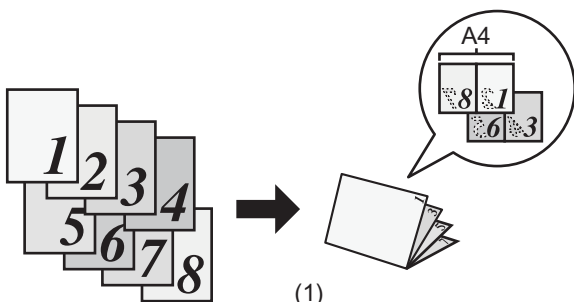



Scanning a document to your computer

Creating a network folder

The example of sharing a folder with the name "sample" with everyone on the network is explained below.

1

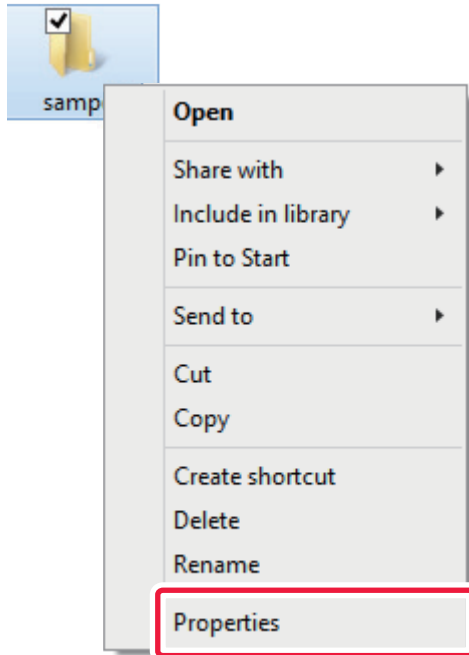

After creating a folder with the name "sample" on the desktop, right-click and select [Properties].

2

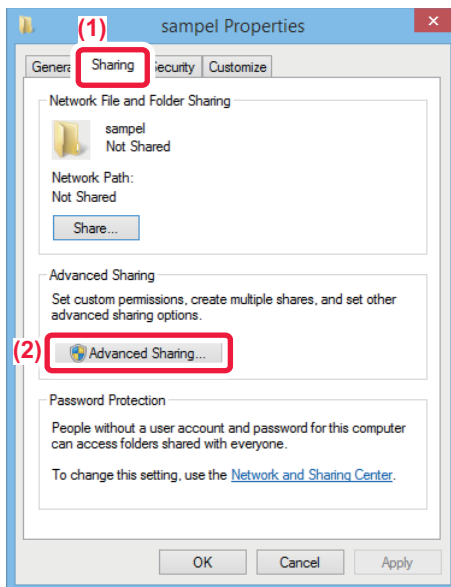

Click [Sharing] and [Advanced Sharing].



3

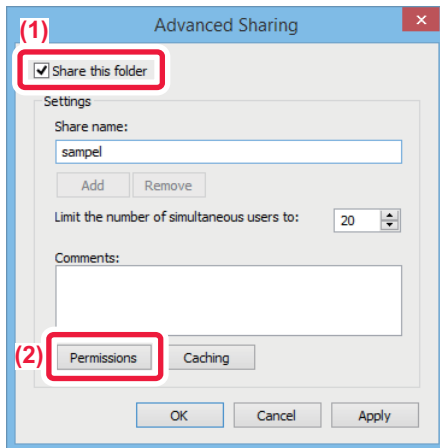

Select the [Share this folder] checkbox and click the [Permissions] button.

4

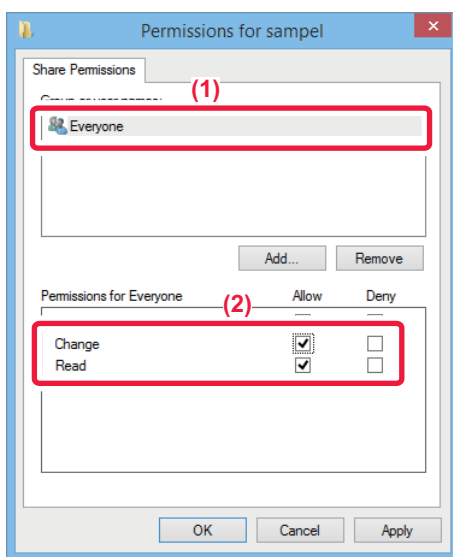

Select "Everyone", select the [Allow] checkboxes of [Change] and [Read], and click [OK].

5

Click the [OK] button in the "Advanced Sharing" screen to close the screen and click the [Close] button.



Sending a document to a shared folder

1

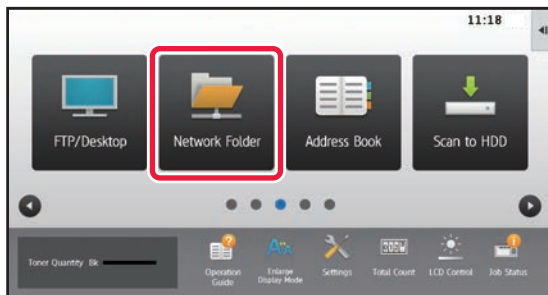

Tap the [Network Folder] mode icon.

2

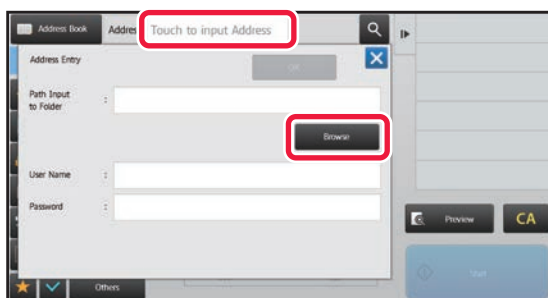

Tap "Touch to input Address" and tap the [Browse] key in the network folder entry screen.

3

Tap the key of the workgroup that you wish to access.



- Tap and enter a keyword to search for a workgroup, server, or network folder.
- Up to 100 workgroups, 100 servers, and 100 network folders are displayed.
- Tap to return to the screen of step 2.

4

Tap the key of the server or computer that you wish to access.

If a screen appears prompting you to enter a user name and password, check with your server administrator and enter the appropriate user name and password.

5

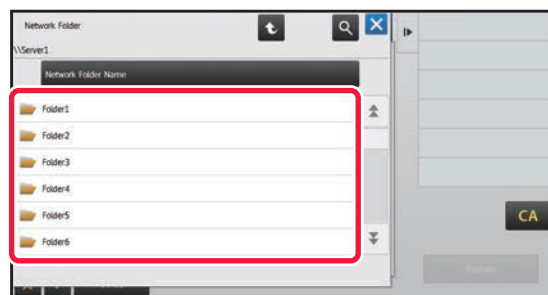

Tap the key of the network folder.



6

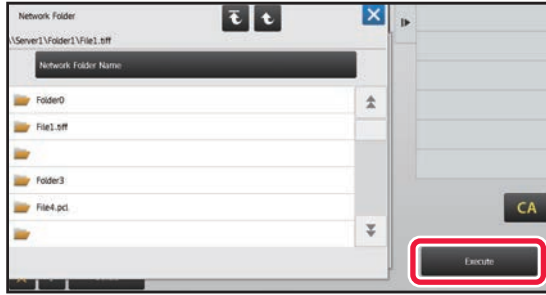

After the settings are completed, tap the [Execute] key.

You will return to the screen of step 2. Tap the [Execute] key again to accept the destination.

7

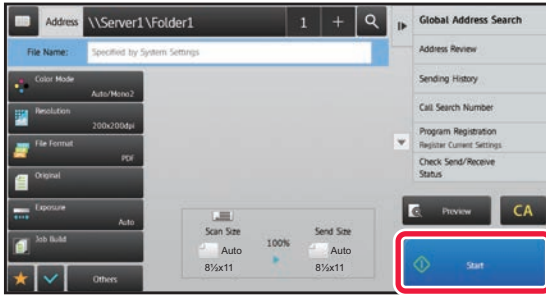



Tap the [Start] key.

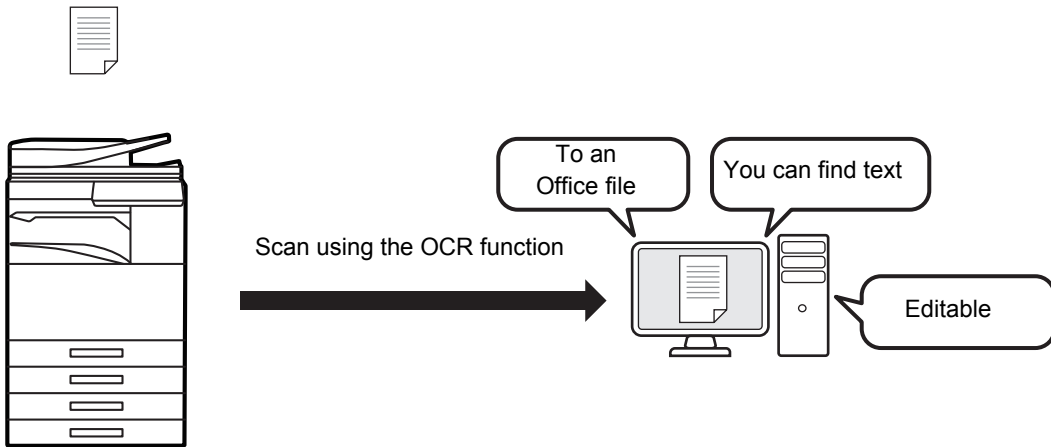

Changing the OCR function (Only when the machine has the OCR function)

You can convert a scanned document directly to an Office file or to a searchable PDF that lets you find text.

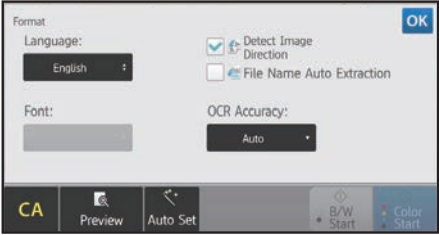
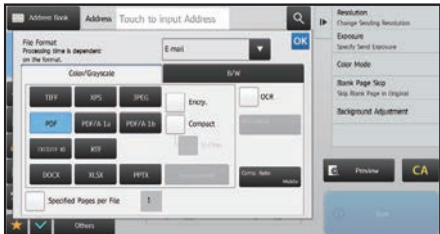
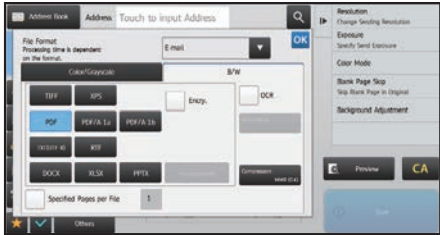
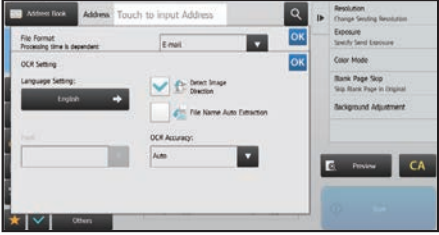

Mode	Format Setting	OCR Setting
Easy mode	<p>When the [Color/Grayscale] key is selected</p>  <p>When the [B/W] key is selected</p> 	
Normal mode	<p>When the [Color/Grayscale] key is selected</p>  <p>When the [B/W] key is selected</p> 	

SHARP®

SHARP CORPORATION